

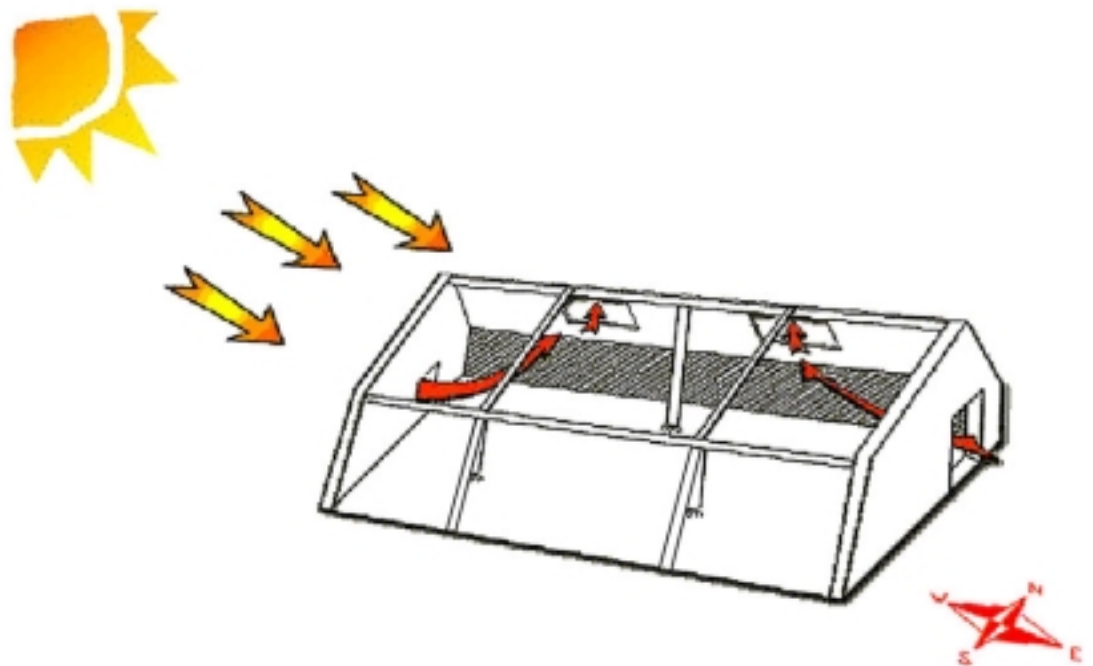

A Manual of Solar Greenhouse Construction

In Ladakh Himalayan Range



Acknowledgement

The greenhouse design proposed in this booklet is the result of practical improvements made by Indian NGOs and by farmers themselves of a design initially proposed by GERES. The main contributors to this design evolution are the marginal farmers of the Trans-Himalayan areas, who, because of their little resources, have been able to reduce the investment cost and to develop practical ideas to facilitate the greenhouse construction.

LEHO (Ladakh Health and Environment Organisation) was the first non governmental organisation to experiment the model and they undertook a huge work to improve the design and to train carpenters and masons to build greenhouses in remote areas.

The following NGOs have also contributed greatly to adapt the initial design to their specific context:

Ladakh (Jammu and Kashmir, India)

- LEHO
- LEDEG (Ladakh Ecological and Development Group)
- LNP (Leh Nutrition Project)
- CRO (Chief Representative Organisation)

Lahaul & Spiti (Himachal Pradesh, India)

- Himachal Pradesh government through watershed project
- Pragya
- Dawa Development

Qinghai (China)

- ATA (Appropriate Technology for Asia)

Badakshn, Hazara Jat, Lowgar and Parwan (Afghanistan)

- Ministry of Animal Husbandry and Agriculture
- AKDN (Agha Khan Development Network)
- AFRANE
- Solidarités

Mustang (Nepal)

- ATA (Appropriate Technology for Asia)

The experimentation, implementation and the redaction of the manual could not be possible without the financial support of **European Commission, French Ministry of Foreign Affairs, Solidarité, Frères de nos Frères** and **ATA**. The greater acknowledgement is for the European Commission which has been supporting field projects in Ladakh, Lahaul&Spiti, Mustang, and Qinghai since 1988.

Foreword

Food security has always been the main preoccupation of mountain communities. Several hundred of millions inhabitants live world-wide in marginal farms with very limited agricultural land, often less than 0.5 hectare per family. Agriculture is focused on cereal growing, in order to reach complete auto-subsistence.

If mountain communities have been able for a long time to survive in a harsh environment, the situation has slightly changed over the last ten years: the demographic explosion is leading to the reduction marginal farms and agricultural area is threatening the environment by increasing the pressure on the limited natural resources. This leads conduct to the pauperisation of the rural population and the depopulation by migration to the main cities.

- Mountain communities are connected to the (other part of the) outside world: road and airport, tourism, public services, central government located in the plain.
- Mountain communities are aware of the economic and social benefits of this evolution, especially for the children education and health.
- Moreover, the migration toward the main cities is often considered as a mean to improve the living conditions, even if it's often a dramatic choice.

Aware of this stakes, GERES has been supporting for 20 years of the mountain communities to enable them to stay in their original area by the strengthening and developing their livelihood. Thus many innovative tools have been improved during a long process, and nowadays they can be considered as adapted:

- Building or retrofitting housing technologies to reduce the fuel wood consumption (dung, bush), used as combustible, which could be valorised in agriculture.
- Tools for agricultural production and transformation (greenhouse, poultry farm, dryer, spinning wheel) adapted the technical and management skill of a household or a women group in order to generate additional income.

Even if during an harsh winter, longer than 6 months, the communities enjoy parties and introspection, it is often considerate as inactive and sad period. The challenge undertaken by GERES , its partners in development (European commission, French Ministry of Foreign Affair) and Indian, Chines, Nepalese and Afghan NGOs is to enable these communities to turn this inactive winter period to account, in order to generate additional income and to contribute to the food security (egg and vegetable production during all the year).

This challenge has been taken up concerning the running of agricultural greenhouses. Several hundreds of them are used Ladakh (India), Quinghai (China), Nepal and nowadays in Afghanistan

This manual of construction will help technical organisations (government services, NGO, development projects...) to enable a large number of communities to grow vegetable during winter in the cold area of Asia, thanks to a greenhouse.

GERES presentation

The Renewable Energy and Environment Group (GERES) is a French NGO created in 1976. It works in a dozen of countries in Asia and Africa, promoting renewable energy resources and energy efficiency through a development process controlled by the local actors. GERES encourages the use of local resources with the objective to respect the environment and provide well-balanced development schemes.

GERES has been working for 20 years for the benefit of local development in the Hindu-Kush Himalayas areas, especially by promoting well adapted and eco-friendly technologies. Our field activities are: energy saving (passive solar building, improve stove) and income generation activities (solar greenhouse, solar poultry farming, eco tourism, food processing, wool transformation...). The first project was set up in Ladakh (India). Nowadays GERES supports local NGOs in India, Nepal, China, Afghanistan and Tajikistan.

Our strategy is based on privileged partnerships with various GOs and NGOs and the participation of the local population. Our projects aim at enabling local communities to earn additional income to access modern services meanwhile preserving the fragile environment of the Hindu-Kush Himalayas areas.



GERES (Renewable Energy and Environment Group)
2, cours Foch - 13400 Aubagne - France
Tel: +33 (0)4 42 18 55 88 Fax: +33 (0)4 42 03 01 56
Web: <http://geres.free.fr/> E-mail : geres@free.fr

Author presentation



Vincent Stauffer, a French Thermal Engineer, is the the main contributor to this manual: he has lead the design process, the experimentation and the diffusion of the model of greenhouse presented in this manual. He has been working since 1992 in the field of solar energy and since 1998 in the Hinda kush – Himalaya area. With GERES, he contributes to the development of solar poultry farm, passive solar housing, improved stove, food processing and woolen transformation in Hindu kush Himalaya.

The other contributors are:

Christophe Viltard (GERES), engineer, for the agricultural experimentation.

Philippe Rynikiewicz (GERES), engineer, for the practical improvement

Rodolphe Castelani (GERES), engineer, for the drawings.

Thomas Mansouri (GERES), communication manager, for the setting up of this manual.

Alain Guinebault (GERES), director, who has initiated these projects.

Tashi Tokhmat, Dorge Raftan and **Gulam Razul**, LEHO members, for the first experimentation.

All the photographs are credited to GERES, excepted N°41 credited to ATA

CONTENT

General index

<i>Acknowledgement</i>	2
<i>Foreword</i>	3
<i>GERES presentation</i>	4
<i>Author presentation</i>	4
CONTENT	5
General index	5
Index of the pictures	6
Index of the figures.....	7
Index of the tables	7
GENERAL INTRODUCTION	8
PART A	11
THEORETICAL ELEMENTS OF PASSIVE SOLAR GREENHOUSES IN COLD AREAS	11
I) THE PASSIVE SOLAR CONCEPT	12
<i>A. Solar radiation in the Trans-Himalaya</i>	12
<i>B. Configuration and orientation of a greenhouse</i>	12
<i>C. Passive solar concept</i>	12
<i>D. The thermal properties of materials</i>	13
The opaque materials.....	13
The transparent materials.....	13
<i>E. Colour of a wall</i>	14
II) WHAT IS A GREENHOUSE?	15
<i>A. The greenhouse concept</i>	15
Vegetable growing depends on two main factors:	15
A solar greenhouse is designed and built:	15
<i>B. Characteristics of a passive solar greenhouse in cold areas</i>	16
1) Picking up solar radiation on south side.....	16
2) Thermal storage and insulation	16
III) SITE SELECTION:	19
<i>A) What are the characteristics of a suitable location site ?</i>	19
Water supply	19
Solar radiation	19
Wind.....	19
Altitude.....	19
The slope of the land:	19
Snow:	20
<i>B) Is a site suitable for a greenhouse ?</i>	20
Qualification of a site	20
<i>C) How to select the best site ?</i>	21
IV) HOW TO SELECT THE BEST DESIGN ?	22
Site:	22
Altitude:.....	22
<i>4 designs according to the site and to the altitude</i>	22
Altitude : below 12.000 ft Design I.....	23
Altitude : between 12.000 ft and 13.500 ft Design II	27
Altitude : above 13.500 ft Design III	31
Altitude : snowy areas Design IV	35
BIBLIOGRAPHY	37
Passive solar	37
Greenhouse construction	37
Greenhouse running	37

PART B.....	38
TECHNICAL GUIDELINES TO BUILD A GREENHOUSE	38
INTRODUCTION TO THE CONSTRUCTION SCHEDULE	39
Before construction	39
The construction	39
TECHNICAL DATASHEET N°1: DRAWING FOUNDATION.....	40
TECHNICAL DATASHEET N°2: BUILDING A DOUBLE WALL.....	42
TECHNICAL DATASHEET N°3: INSTALLING AN ACCESS DOOR	45
TECHNICAL DATASHEET N°4: INSTALLING A SIDE SHUTTER AS VENTILATOR.....	47
TECHNICAL DATASHEET N°5: BUILDING A PARTITION WALL	49
TECHNICAL DATASHEET N°6: INSTALLING A ROOF ON A GREENHOUSE	50
TECHNICAL DATASHEET N°7: INSTALLING POLYTHENE FILM.....	54
TECHNICAL DATASHEET N°8: INSTALLING A SHUTTER ON THE ROOF AS VENTILATOR	57
TECHNICAL DATASHEET N°9: PROVIDING NIGHT INSULATION	59
TECHNICAL DATASHEET N°10 MATERIAL LISTING AND COST ESTIMATE	61
ANNEXES.....	63

Index of the pictures

<i>Picture 1 - View of Mustang (Nepal) high valley</i>	<i>8</i>
<i>Picture 2 - Solar greenhouse built in Leh (Ladakh, India)</i>	<i>9</i>
<i>Pictures 3, 4 - Inside views of a greenhouse in Ladakh</i>	<i>15</i>
<i>Pictures 5, 6, 7 - Greenhouse's structure</i>	<i>16</i>
<i>Picture 8 - Greenhouse in construction (view of the double walls and the structure of the roof)</i>	<i>17</i>
<i>Picture 9 - Ventilator opening.....</i>	<i>18</i>
<i>Picture 10 - A team constructing a greenhouse in Qinghai</i>	<i>39</i>
<i>Picture 11 - View of south tracing by means of "plumb-line" method</i>	<i>40</i>
<i>Picture 12 - " 3, 4,5 method "</i>	<i>40</i>
<i>Picture 13 - Excavation of the slope</i>	<i>41</i>
<i>Picture 14 - A 2 inch thick layer of concrete at the top of the foundations</i>	<i>41</i>
<i>Pictures 15 & 16 - Forming the shape with a rope (in Qinghai and Ladakh)</i>	<i>42</i>
<i>Picture 17 - Building of double wall with mud bricks in Ladakh</i>	<i>42</i>
<i>Picture 18 - Construction of the outer wall with baked bricks and the inner wall with stabilised rammed earth in Qinghai</i>	<i>42</i>
<i>Picture 19 - View of double wall and insulation filling (sticks are added to reinforce the gap).....</i>	<i>43</i>
<i>Picture 20 - View of suitable insulation materials</i>	<i>43</i>
<i>Picture 21 - View of white washed west wall and black painted north wall.</i>	<i>43</i>
<i>Picture 22 - Door construction</i>	<i>45</i>
<i>Picture 23 - Detail of the masonry procedure for building the doorway supporting wall</i>	<i>46</i>
<i>Picture 24 - The second shutter covered by metal band</i>	<i>46</i>
<i>Picture 25 - Making of ventilator frame.....</i>	<i>47</i>
<i>Picture 26 - Frame positioning on wall</i>	<i>47</i>
<i>Pictures 27 & 28 - View of installed side shutter with chicken mesh outside</i>	<i>48</i>
<i>Picture 29 - View of partition wall construction.....</i>	<i>50</i>
<i>Pictures 30 & 31 - Beam fixation on the post in Ladakh (left) and Qinghai (right)</i>	<i>50</i>
<i>Picture 32 - View of a general greenhouse structure</i>	<i>50</i>
<i>Picture 33 - One horizontal beam and several transversal joists in Spiti</i>	<i>51</i>
<i>Picture 34 - View of sticks.....</i>	<i>52</i>
<i>Picture 35 - Small overhang on the backside of the greenhouse in Spiti</i>	<i>52</i>
<i>Picture 36 - Applying of cardboard, straw and Mud</i>	<i>52</i>
<i>Picture 37 - White cloth under the roof.....</i>	<i>53</i>
<i>Picture 38 & 39 - A roof structure made of timber and bamboo in Qinghai</i>	<i>53</i>
<i>Picture 40 - Wooden structure to support polythene (Lowgar, Afghanistan)</i>	<i>54</i>
<i>Picture 41 - Earth exfoliation due to joists resting directly on the earth</i>	<i>54</i>
<i>Picture 42 - Detail of polythene fixing by use of bricks laid on a mud coating.</i>	<i>55</i>
<i>Picture 43 - General view of polythene fixing by use of bricks.</i>	<i>55</i>
<i>Picture 44 - South face of polythene lifted to improve cooling</i>	<i>56</i>
<i>Picture 45 & 46- Views of roof ventilator implementation and operating</i>	<i>58</i>
<i>Picture 47 - Top view of roof ventilator</i>	<i>58</i>
<i>Picture 48 - View of installed night insulation</i>	<i>60</i>

Index of the figures

Figure 1 - Seasonal variation of solar radiation	12
Figure 2 - Configuration and orientation of a greenhouse	12
Figure 3 - Passive solar concept in a greenhouse	12
Figure 4 - The greenhouse effect.....	13
Figure 5 - Absorbivity related to the colour.....	14
Figure 6 - View of air circulation in a greenhouse	18
Figure 7 - Design 1A - Greenhouse below 12000 ft, Flat land.....	24
Figure 8 - Design 1B - Greenhouse below 12000 ft, Upward slope north orientated	25
Figure 9 - Design 1C - Greenhouse below 12000 ft, Land adjacent to a south orientated step	26
Figure 10 - Design 2A - Greenhouse between 12000 and 13500 ft, Flat land.....	28
Figure 11 - Design 2B - Greenhouse between 12000 and 13500 ft, Upward slope north orientated.....	29
Figure 12 - Design 2C - Greenhouse between 12000 and 13500 ft, Land adjacent to a south orientated step.....	30
Figure 13 - Design 3A - Greenhouse above 13500 ft, Flat land.....	32
Figure 14 - Design 3B - Greenhouse above 13500 ft, Upward slope north orientated	33
Figure 15 - Design 3C - Greenhouse above 13500 ft, Land adjacent to a south orientated step	34
Figure 16 - Design 4 - Greenhouse in snowy areas.....	36
Figure 17 - Bisecting lines method to draw a right angle.....	41
Figure 18 - Double wall construction.....	44
Figure 19 - Door frame.....	45
Figure 20 - Doorway frame	45
Figure 21 - Door positioning (elevation).....	46
Figure 22 - Drawing of the masonry procedure for building the doorway supporting wall.....	46
Figure 23 - Frame installation.....	47
Figure 24 - Plan view of greenhouse with partition walls constructed.....	49
Figure 25 - Wall building, beam positioning	51
Figure 26 - Roof composition	52
Figure 27 - Wooden support for polythene	54
Figure 28 - Rope net maintaining polyethylene sheet in case of windy weather.....	56
Figure 29 - View of air circulation through roof ventilator.....	57
Figure 30 - Details of frame construction.....	57

Index of the tables

Table 1 - Suitability of a site for the implementation of a greenhouse project	20
Table 2 - Criteria marking system.....	21
Table 3 - Site selection table.....	21
Table 4 - Select the best design according to the altitude.....	22
Table 5 - Characteristics for areas below 12000 ft.....	23
Table 6 - Characteristics for areas between 12000 and 13500 ft	27
Table 7 - Characteristics for areas above 13500 ft.....	31
Table 8 - Characteristics for snowy areas	35
Table 9 - Material listing and cost estimate.....	61

GENERAL INTRODUCTION

The north parts of the Hindu Kush and Himalayan ranges are a cold desert between 2500 m and 5000 m above sea level. This area, often called Trans-Himalayas, goes from the Tajikistan in the West to the Buthan in the East with the Tibetan Plateau as central part. The environment is very harsh: the winter temperature are frequently falling below -30°C , the rain and snowfall are limited (less than 300 mm per year), some villages are considered as the highest in the world. In this cold desert, the natural resources are very limited and the lack of trees and forests conducts to a very low population density.

During the short summer season; the communities devote their energy to stocking their houses for the winter. Women spend two months per year to collect in pastureland cowdung to cook and heat the space in winter. The way of life and agricultural system of the inhabitants is geared toward surviving the long and harsh winter: the self-subsistence agricultural production is limited in most of the area to one crop per year and is focused on barley and wheat with additional peas, potatoes and sometimes vegetables. The average agricultural land area is small, less than 1/2 hectare per household. In high altitude plateau, the inhabitants are fully depending on cattle rearing. The poor transportation infrastructure limits the supply of fresh food. In winter, when the snowfall block the high passes and the road are usually closed, the food are supplied by airplane at a high cost in the main city and are not available in the rural area.

On the other hand, the climate is very sunny, especially during the winter period. The solar radiation can be used not only to warm the space domestic houses, schools, dispensaries, handicraft centres... but also to develop off-season agricultural activities such as composting, greenhouses, trench greenhouses, poultry farms etc.



Picture 1 - View of Mustang (Nepal) high valley

This booklet focuses on greenhouse design and construction

The climate inside a solar heated greenhouse is suitable to grow vegetables all the year round, even in winter. This tool is relevant in the areas where the needs for food security and economic development are great most of the time. The main benefits are to

- Enable vegetables production in winter.
- Fulfil basic subsistence in remote areas.
- Contribute to the creation of new incomes in peri-urban areas.

The model proposed in this manual is a efficient greenhouse constructed with local materials (excepted polythene). The initial model has been improved by the Indian farmers and the Indian NGOs to reduce the investment cost, facilitate the construction and improve the lasting. These greenhouses have been popularised in

India (Lahaul, Spiti, Ladakh), China (Qinghai province), Nepal (Mustang) and Afghanistan. The design is also suitable in other areas of the Hindu Kush, Himalaya and Pamir ranges characterised by similar climatic and socio-economical context such as:

- In India : the high valleys of Sikkim and Arunachal Pradesh.
- In Nepal : the areas of Humla, Simikot, Dolpo and Mustang.
- The Tibetan Plateau and Bhoutan.
- In Central Asia: Afghanistan, Tadjikistan and Kirghizstan.
- In Pakistan: the areas of Chitral and Baltistan

Vegetable can be grown in peak winter even the temperature are falling below -15°C . In very cold climate such as Leh (3500m, India, -20°C in winter), leaf vegetable (salad, spinach) and some root vegetable (carrot, tomato) can be grown in winter. The greenhouse is even more efficient in cold climate area such as Kabul (1800m, Afghanistan, -5°C in January) where fruit vegetable (eg. tomato) can be harvested until January. The average growing efficiency of fresh vegetable is $0,8\text{ kg/m}^2$ of in very cold climate and $1,4\text{ kg/m}^2$ in cold climate. A typical production of a greenhouse is presented in the next table

Season/period	Cold climate (-5°C in winter)	Very cold (-15°C in winter)
Winter	Fruit vegetable if planted in Autumn Root vegetable	Root vegetable if planted in Autumn Leafy vegetable
Spring	Seedling Root/fruit vegetable	Seedling Root/fruit vegetable
Summer	Exotic vegetable	Exotic vegetable
Autumn	Fruit vegetable	Fruit vegetable



Picture 2 - Solar greenhouse built in Leh (Ladakh, India)

A solar greenhouse is adapted to the local context

- Materials are locally available (mud, wood, straw), except for the transparent cover sheet.
- Construction is managed by local builders.
- Its reasonable cost is paid off in less than 3 years if the production is well-managed and sold.

A tool enabling Man development.

- by empowering women, since they are often in charge of the production and the selling.
- by limiting nutritional deficiency through a more diversified food production all year long.

If a greenhouse is an interesting tool for development, it is efficient only if it is well used. Past experiences have shown the importance of planning a dissemination method.

- the selection of the stakeholders

- Communities of poor families.

- Innovative and dynamic farmers.
- the selection of the site
 - Water availability (river, well, canals, snow).
 - direct and abundant sunshine.
 - The need to adjust dimensions and materials to the site.
 - Minimisation of the waste of land on the backside
- the setting up of facilities
 - Complementary training of the builders.
 - Farmers training on greenhouses cultivation.
 - Developing network for seeds, tools and polythene supply and vegetable marketing

This manual focuses on the design and construction guidelines of efficient greenhouse. The economical feasibility , the dissemination methodology and the agricultural running are explained in other booklets to be published.

The first part of this manual presents the theoretical principles to help understand the passive solar greenhouse concept in cold areas and select suitable sites and designs.

The second part focuses on the practical construction elements and explains in detail every step that must be taken into consideration to obtain an efficient greenhouse.

PART A
**THEORETICAL ELEMENTS OF PASSIVE SOLAR
GREENHOUSES IN COLD AREAS**

I) The passive solar concept

A. Solar radiation in the Trans-Himalaya

The amount of solar energy picked up by a greenhouse depends on the position of the sun in sky. In the morning, the sun rises on the east. Going up, it moves toward the south. At midday, it reaches its highest position on the south. Then, going down, it sets on the west in the evening.

The sun is higher in the sky in summer than in winter. In summer, when the sun is high in the sky, most of the solar radiation is picked up by the roof or any other horizontal area.

During winter, when the sun is low, the south face picks up the largest amount of solar radiation: the sun warms the east face during the morning, at midday the south face is exposed to solar radiation and during evening time, the west face picks up the sun energy. The north wall is always in the shade.

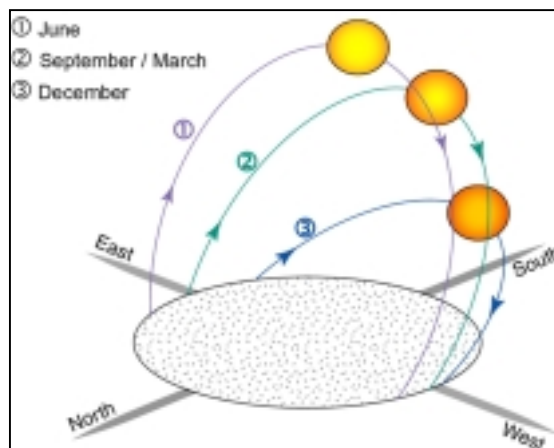

Figure 1 - Seasonal variation of solar radiation

The sides of a greenhouse exposed to the sun gain heat during the day while the other sides, in the shade, lose heat.

B. Configuration and orientation of a greenhouse

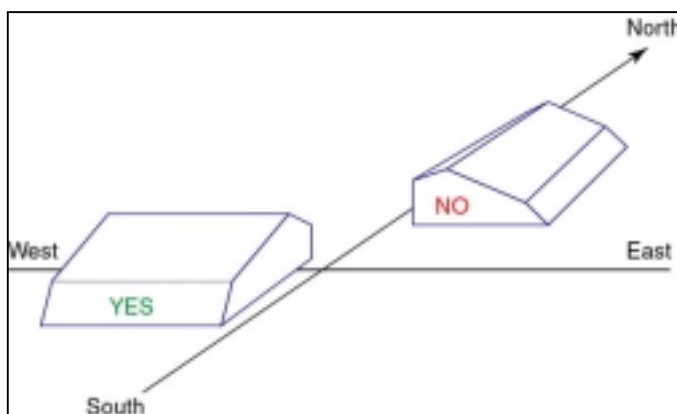

Figure 2 - Configuration and orientation of a greenhouse

A passive solar greenhouse aims at absorbing during the winter the maximum amount of solar radiation to warm the inner space and to enable vegetable growth in a temperate climate

A passive solar greenhouse is designed along an east – west axis : the south face length is increased to present the largest possible surface area to the sun. The east and west facing walls are reduced to minimise their heat loss and the shade inside the greenhouse.

C. Passive solar concept

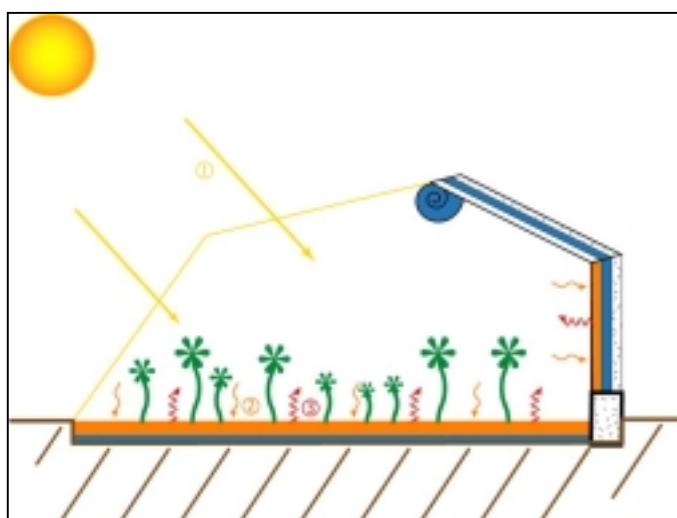

Figure 3 - Passive solar concept in a greenhouse

One may think that the collection of a large amount of solar radiation is enough to warm the inner space of a greenhouse during the day and the night. However, although the absorption of the solar radiation warms the space during the day, as soon as this absorption stops at night, the greenhouse may become cold. 4 inter-related components work together to make the building an efficient user of energy:

1. Collection of the maximum amount of solar radiation during the day.
2. Storage of the heat collected from the sun radiation during the day.
3. Release of this heat to the interior of the building during the night
4. Insulation of the whole greenhouse to retain as much heat as possible in the greenhouse.

D. The thermal properties of materials

The thermal behaviour of the materials used in the construction of a greenhouse are different. The materials are selected according to passive solar concept.

The opaque materials

These materials block solar radiation, however they allow the transfer of energy through them by conduction. These materials can be distributed in two families.

The **dense** materials (brick, stone, cement) can conduct and store heat. Usually, excepted metallic material, the heavier is a material the faster and the larger amount of solar energy can be stored. In a greenhouse, this dense materials acts

as loadbearing material: the walling supporting the polythene frame and the roof
as the thermal mass

The **low density** materials (or light such as straw, sawdust, woodshaving, dry leaves, wild grass,...) can neither conduct, neither store the heat. Acting as an insulator, they help to retain the heat inside the greenhouse. These materials, not load bearing, are filled in the cavity between the loadbearing wall and the thermal mass wall

The transparent materials

Materials, such as glass, transparent polythene..., allow radiation to pass through them and transmit this radiation to the inner space.

The transmittance is high when the sun is perpendicular (or up to a angle of 30°) but decreases strongly when the angle is over 50°.

The transmission is higher trough glass (90%) than trough polythene (80 %).

An important characteristic of transparent materials is the **greenhouse effect**. The majority of **incident** solar radiation is transmitted through a pane of glass. This radiation heats the inside surfaces of the glazed room.

The inside temperature rises because the radiative heat losses from the inner surfaces to the outside environment are re-reflected into the greenhouse by the transparent cover. Therefore, once solar radiation has been transmitted through the cover it cannot be transmitted back through the cover. This is because the wavelength of the radiation re-emitted by the inner surface of the greenhouse is different that the solar radiation wavelength: the transparent cover transmits the solar radiation but blocks the infra-red radiation emitted by the inner materials

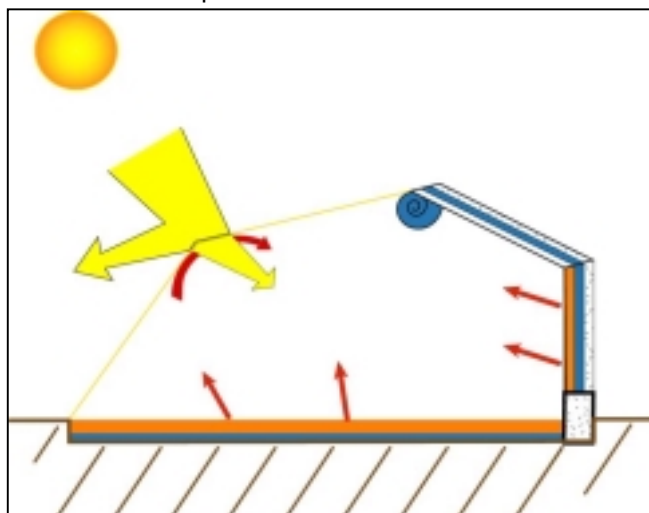

Figure 4 - The greenhouse effect

The greenhouse effect works also with polythene, but the process is 50 % less efficient than with a glass cover.

A greenhouse covered by polythene is much cheaper than a similar one covered by glass but is colder during night if no extra-moveable insulation is added

	glass	polythene
advantages	- higher transmission - less heatloss	- cheap - easy to carry - easy to repair
disadvantages	- expensive - replacement if breakage - difficult to carry	- less efficient - short life (especially if windy area) - not biodegradable

E. Colour of a wall

The amount of solar energy **absorbed** by a material is linked with its colour. The colour white reflects most of the sun's radiation, while black absorbs most of it.

The proportion of the sun radiation absorbed by a specific colour is called absorptivity.

COLOUR	ABSORPTIVITY
White	0.25 to 0.4
Grey to dark grey	0.4 to 0.5
Green, red, brown	0.5 to 0.7
Brown to dark blue	0.7 to 0.8
Dark blue to black	0.8 to 0.9

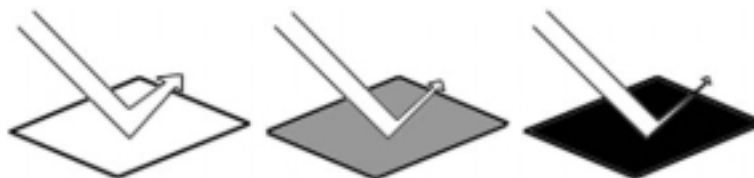

Figure 5 - Absorptivity related to the colour

II) What is a greenhouse?

A. The greenhouse concept:

A greenhouse is designed to provide a climatic environment suitable to vegetable need for growing.

Vegetable growing depends on two main factors:

- Solar radiation: vegetables need solar radiation for the photosynthesis process.
- The interior climate: the interior environment (temperature and humidity) has to match with the vegetable requirements. This climate has to be temperate during the day and night. When the outside condition are very cold, the heat from the solar energy is stored during the day in the ground and the walls and released during the night to maintain warm the greenhouse so that risks of freezing damages are limited. A cooling system by natural ventilation avoids overheating during the sunny hours and contributes to regulate humidity and to limit the development of disease and pests. The temperature variation between day and night has to be minimum to reduce the thermal stress of the vegetable.



Pictures 3, 4 - Inside views of a greenhouse in Ladakh

A solar greenhouse is designed and built:

- To pick up enough solar radiation for the photosynthesis process
- To match the interior climatic conditions with the required vegetable growing conditions all the year round.

The yearly running of a greenhouse is thus:

- During winter time, the greenhouse picks up and stores enough solar radiation during the day time in order to release this heat during the coldness of the night.
- During sunny days, the greenhouse is cooled during the warmest hour of the day by natural ventilation through a manually operated opening, called a ventilator.

This means that a passive solar greenhouse:

- ✓ picks up solar radiation
- ✓ stores this radiation as heat in the mass of the walls during day time
- ✓ releases this heat during night time to warm the interior space
- ✓ is insulated to retain this heat
- ✓ can be ventilated to avoid overheating

In cold area, a passive solar greenhouse is composed of three main parts.

- Walls on the east, west and north sides,
- A polythene sheet on the south side supported by a wooden frame,
- A roof on the north side.

Walls are built on the east, west and north faces where the amount of solar energy is limited. These walls are either buried into the hillside or insulated to limit heat loss and increase thermal storage.

Polythene is put on the south side, which picks up the largest amount of solar energy in winter. The polythene transmits into the greenhouse the majority of solar radiation which warms the interior space and is picked up by the vegetables, the ground and the walls. If the main solar gain is through the polythene during daytime, the main heat loss from a greenhouse is also through this polythene during night time. If no heat is stored inside the walls during day time and no moveable insulation, such as a curtain, cloth etc. is added after sunset, a greenhouse is very cold during night time.

A roof is built on the north side to limit heat loss. It is tilted to increase the amount of solar radiation absorbed into the greenhouse and reduce the interior volume.



Pictures 5, 6, 7 - Greenhouse's structure

B. Characteristics of a passive solar greenhouse in cold areas

The characteristics of a passive solar greenhouse are explained below:

1) Picking up solar radiation on south side

The solar radiation are picked up through the transparent polythene sheet that covers the greenhouse on the **south face**. The angle of the polythene is calculated so that the maximum amount of solar radiation can be transmitted into the interior.

The angle of the polythene on the lower section of the wall is 50° (minimum, measured from the horizontal) to transmit solar radiation to the crops in the early morning or late afternoon.

The angle of the polythene on the upper section of the wall is 25° (minimum, measured from the horizontal) to transmit the mid-day solar radiation and drain out the snow.

After sunset, a movable insulation (parachute, cloth) covers the polythene to reduce the heat loss and increase the ground and interior temperature by 5°C. This movable insulation is removed after sunrise.

In high altitude, double polythene reduces the heat loss and increases the temperature during night time by 4°C

2) Thermal storage and insulation

Several factors are involved:

Double wall

The walls are composed of 3 layers :

- The inner layer stores the heat during the day and releases it during the night. It can be built with mud brick, rammed earth or stone.
- An insulation layer (straw, wild bush, sawdust...)
- A outer load bearing wall built with mud brick, rammed earth or stone.

Colour

The colour white reflects solar radiation while the colour black absorbs solar radiation. This simple principle is directly applied to greenhouse design.

- The inner side of the west wall is white washed to reflect the morning solar radiation after the coldness of the night.
- The inner side of the east wall is painted black to absorb and store the afternoon solar radiation. This radiation will be released at night to heat the interior space.
- The lowest 2 feet of the inner side of the north wall are white washed, the upper part is black painted.

Roof

- The slope of the roof is 35°. In winter, as the sun has a low elevation angle, this angle optimises the solar radiation gain. During summer, the sun is high in the sky, thus the roof shades partly the greenhouse and limits the risks of overheating.
- An insulation layer (straw, wild bush....) insulates the roof. A white parachute or white cloth can be added below the roof to improve the insulation and reflect solar radiation to the vegetables.
- This shape reduces the interior volume compared to traditional greenhouses, thus the interior temperature is warmer.

Ground

The suitable agricultural land is 6" underground. At high altitude, a 2" layer of horse dung located 4 inches below the agricultural surface insulates the ground and increases the thermal mass efficiency.

Door

The door is located on the wall opposite to the wind to reduce the infiltration of cold air.



Picture 8 - Greenhouse in construction (view of the double walls and the structure of the roof)

3) Ventilation

During the sunny days, the inner air of the greenhouse can be very warm (over 40°C). This overheating damages vegetable and encourages disease and pests. Manually operated openings are provided on the bottom of both sides (door, wall ventilator) and at the top of the greenhouse. As the warm air rises, the cooler ambient outer air enters the greenhouse through the bottom ventilator, cools the greenhouse and get warmer; finally rising and exiting the greenhouse through the roof ventilator.

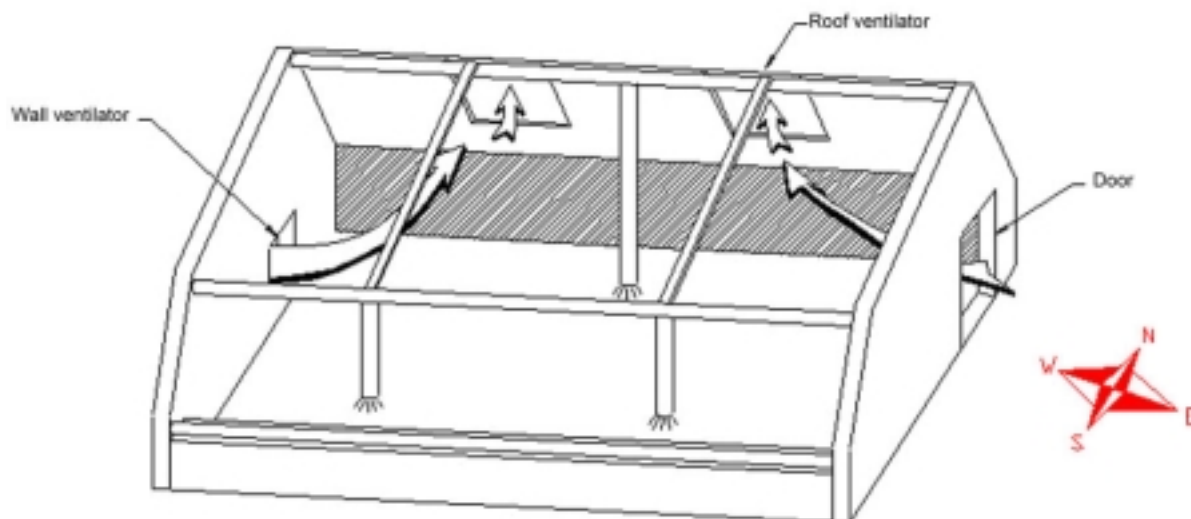

Figure 6 - View of air circulation in a greenhouse



Picture 9 - Ventilator opening

III) Site selection:

A) What are the characteristics of a suitable location site ?

Water supply

In open fields or in a greenhouse, vegetables require water to grow. During the coldness of the winter, the greenhouse is less ventilated, the evaporation is lower and moisture is retained inside, thus a small amount of water is required. But in spring and summer, the greenhouse is ventilated during daytime to avoid overheating : some moisture is exhausted within the air during ventilation and a larger amount of water is required by the vegetables.

During winter and spring, many streams and springs are frozen, thus running water may be located so far from the site that transportation could discourage the farmers from operating their greenhouses.

As the amount of water required is larger in spring than in winter, the crucial period is spring. The distance to the nearest running water has to be acceptable during this period.

The maximum distance that the farmer can manage to carry water is 250 feet in winter and 150 feet in spring and summer.

Solar radiation

Solar radiation are required to grow vegetables and to heat the greenhouse. If the sunrise is too late or the sunset too early, the greenhouse remains cold for longer and vegetable production is reduced. Nearby obstacles can also shade the greenhouse.

The sunrise must be before 9:30 am and the sunset later than 3 pm.

Wind

If the door of the greenhouse is exposed to wind, the infiltration of cold ambient air decreases the inner temperature of the greenhouse.

The door must always be located on the opposite side from the wind.

Altitude

Temperature decreases with altitude, thus a similar greenhouse will be more efficient at a lower valley altitude than on a high plateau. For higher altitudes the design is improved with a larger thermal mass, ground insulation, smaller width etc..

The greenhouse is designed according to the altitude where it is to be located, in order to be more efficient in higher areas.

The slope of the land:

The slope of the land influences the amount of solar radiation picked up, the ground temperature and the heat loss through the walls.

A site is **suitable** if :

- the land is flat and dry.
- the upward part of the land is towards the north: the amount of solar radiation is increased by ground reflection and as the greenhouse is partly underground, the ground is warmer and the heat loss through the walls is reduced.
- the land has a south facing step: this step can be used for the north face of the greenhouse and may support the roof. The benefits are a lower investment cost, warmer ground and a larger thermal mass if the step is built using stone masonry.

A site is **rejected** if

- the upward part of the land is towards the south: the amount of solar radiation is decreased.
- the land has a north facing step: the greenhouse has to be oriented north and the benefits will be limited.
- the land is marshy: the ground freezes easily in winter and the vegetables may also freeze.
- the site is a not an agricultural land (stone, sand....)

Snow:

Heavy snowfall can damage the polythene laid over the greenhouse if an considerable weight of snow remains above it. In snowy areas, the slope of the polythene has to be high so that the snow slips off it.

B) Is a site suitable for a greenhouse ?

Qualification of a site

A site is suitable to implement a greenhouse project if all the following criteria are validated :

Table 1 - Suitability of a site for the implementation of a greenhouse project

Feature	Criteria	Site survey	Condition	Validated Y/N
Shading survey	sunrise		< 09.30 AM	
	sunset		> 03:00 PM	
	obstruction during this period		no	
	nearby obstruction		no	
Water management: distance to the nearest water point	December- March		< 250 feet	
	April to October		< 150 feet	
Site	flat			
	slope		upward part of slope towards north	
	if stepped		site adjacent to south facing step	
	marshy/ dry		dry	
Qualification				

C) How to select the best site ?

As we have seen, site selection depends on several criteria and may be difficult for an unskilled person. To help people select a site we propose a simple selection tool which consists of giving a mark to each criteria and, after adding all marks, comparing one site to another.

Criteria marking system :

Table 2 - Criteria marking system

CRITERIA	MARK
Distance to running water in winter	
less than 30 feet	5 points
less than 50 feet	4 points
less than 100 feet	3 points
less than 150 feet	1 point
less than 250 feet	0 point
Distance to running water in springtime	
less than 30 feet	6 points
less than 50 feet	5 points
less than 100 feet	2 points
less than 150 feet	0 point
Slope of the site	
Site adjacent to a south facing step (step is between 1.5 to 4 feet high)	5 points
Upward part of slope towards north	3 points
Flat	2 points
Flat and marsh land:	1 point
Sunrise in January	
Before 07:30 am	8 points
08:00 am	6 points
08:30 am	4 points
09:00 am	2 points
09.30 am	0 point
Sunset in January	
After 05:00 pm	6 points
04.30 pm	5 points
04:00 pm	4 points
03.30 pm	2 points
03:00 pm	0 point

Now, for each site surveyed, fill in the following table. Select the site with the highest score.

Table 3 - Site selection table.

Criteria	Description	Score
Distance to water in winter		
Distance to water in spring		
Slope of site		
Sunrise		
Sunset		
TOTAL		

IV) How to select the best design ?

Several factors influence the design of a greenhouse : the site, the altitude and the snowfall. Thus, 9 designs have been developed according to 3 different types of land and 3 altitude ranges. A design has also been developed for snowy areas.

Site:

3 types of site are distinguished:

- Flat and dry Shape A
- Upward part of slope towards north Shape B
- Adjacent to a south facing step Shape C

Altitude:

The Chang Tang area is divided into 3 levels of altitude:

- Below 12,000 feet
- Between 12,000 and 13,500 feet
- Above 13,500 feet

Table 4 - Select the best design according to the altitude

Site	Altitude			Snowy areas
	Below 12,000ft	Between 12,000ft and 13,500ft	Above 13,500ft	
Flat	Design I.A	Design II.A	Design III.A	Design IV
Upward part of slope towards north	Design I.B	Design II.B	Design III.B	
Adjacent to south facing step	Design I.C	Design II.C	Design III.C	

Note: The location of the door depends on wind direction: the door is always constructed on the wall opposite to the wind in order to limit cold air infiltration.

4 designs according to the site and to the altitude

(for translation of the dimensions in cm, see Annexes)

Design I is suitable for **the lowest villages of Chang Tang, located below 12000 ft**, such as Skyok.

Table 5 - Characteristics for areas below 12000 ft

CRITERIA	CHARACTERISTICS	DESIGN I DATAS
STRUCTURE	Orientation	South
	External dimensions	32x17 feet
	Internal dimensions	28'4"x14'
	Door positioning	Opposite to wind
	Inner partition	No
	Roof slope	30°
	Agricultural land burying depth.	6"
INSULATION	Wall insulation	4"
	Roof insulation	1"1/2
	Ground insulation	No
VENTILATION	Wall ventilation	Yes
	Roof Ventilation	2 roof ventilators
POLYTHENE	Single / Double	Single
	Manually operated night insulation	Yes

According to the site, select design I.A., I.B. or I.C.

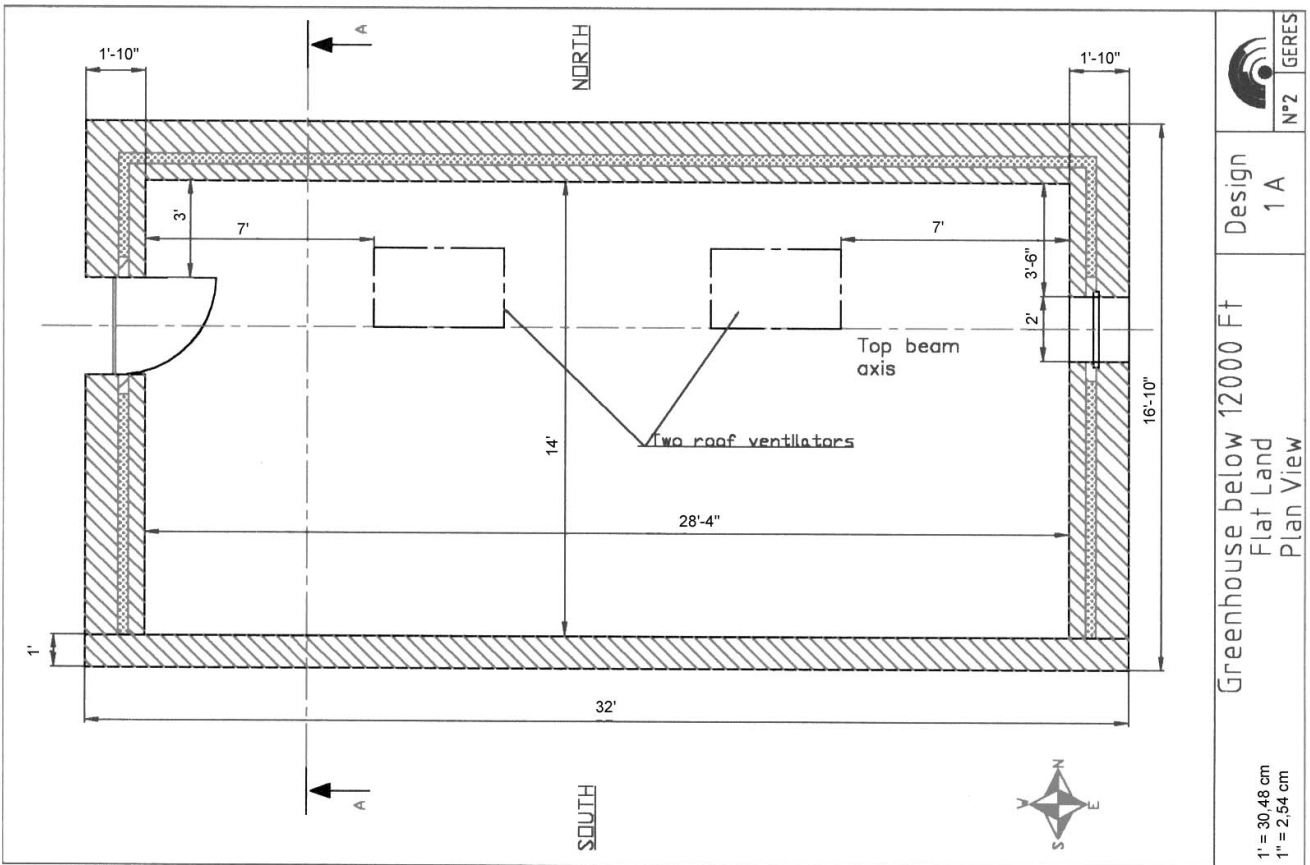
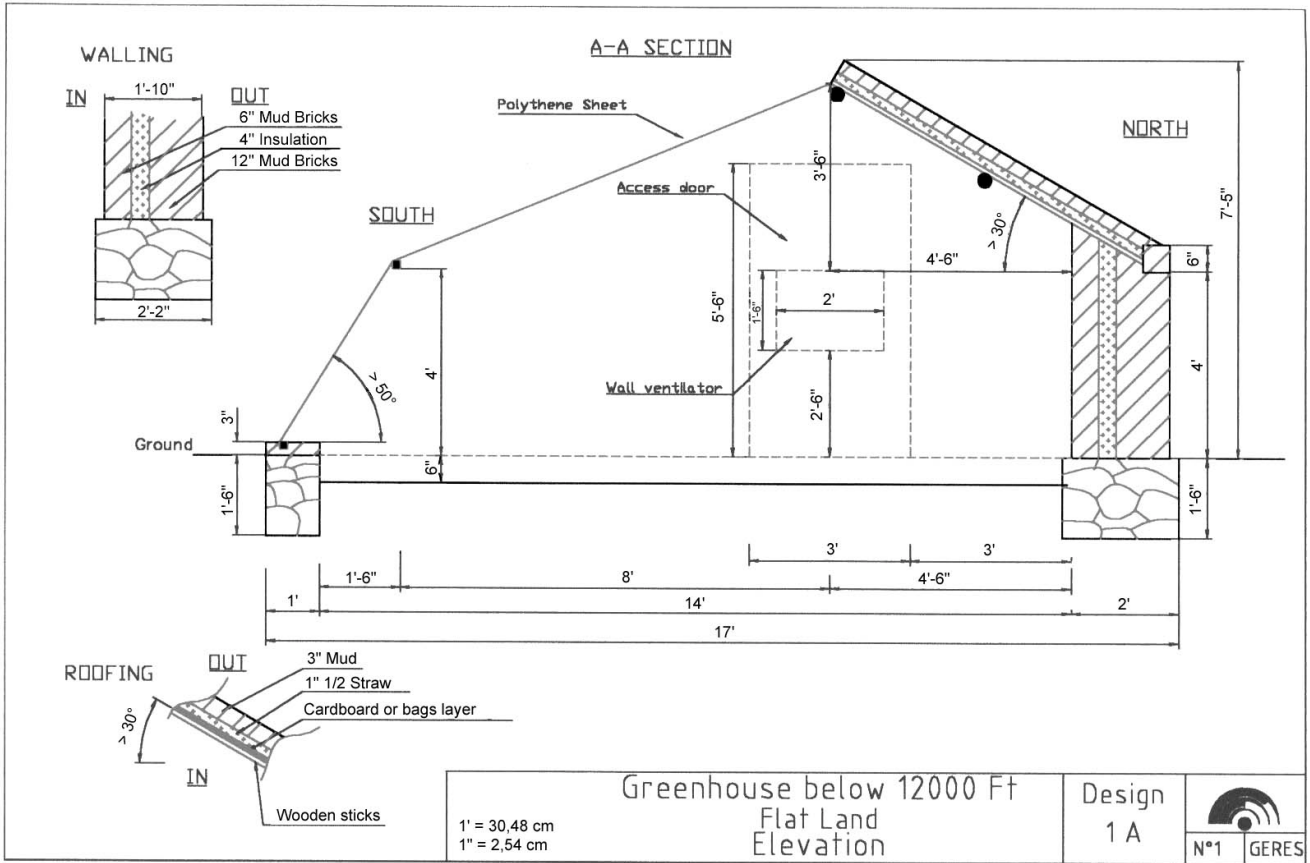

Figure 7 - Design 1A - Greenhouse below 12000 ft, Flat land

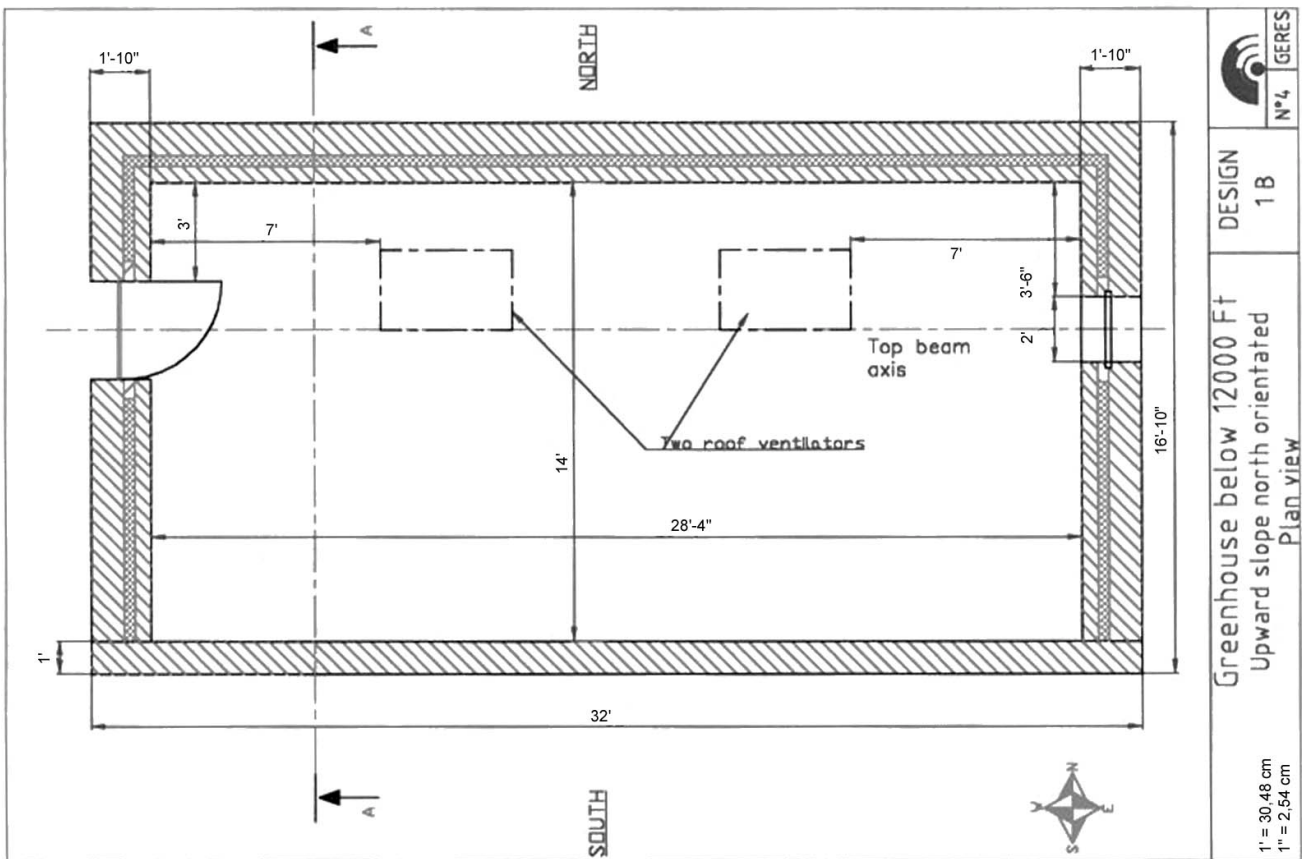
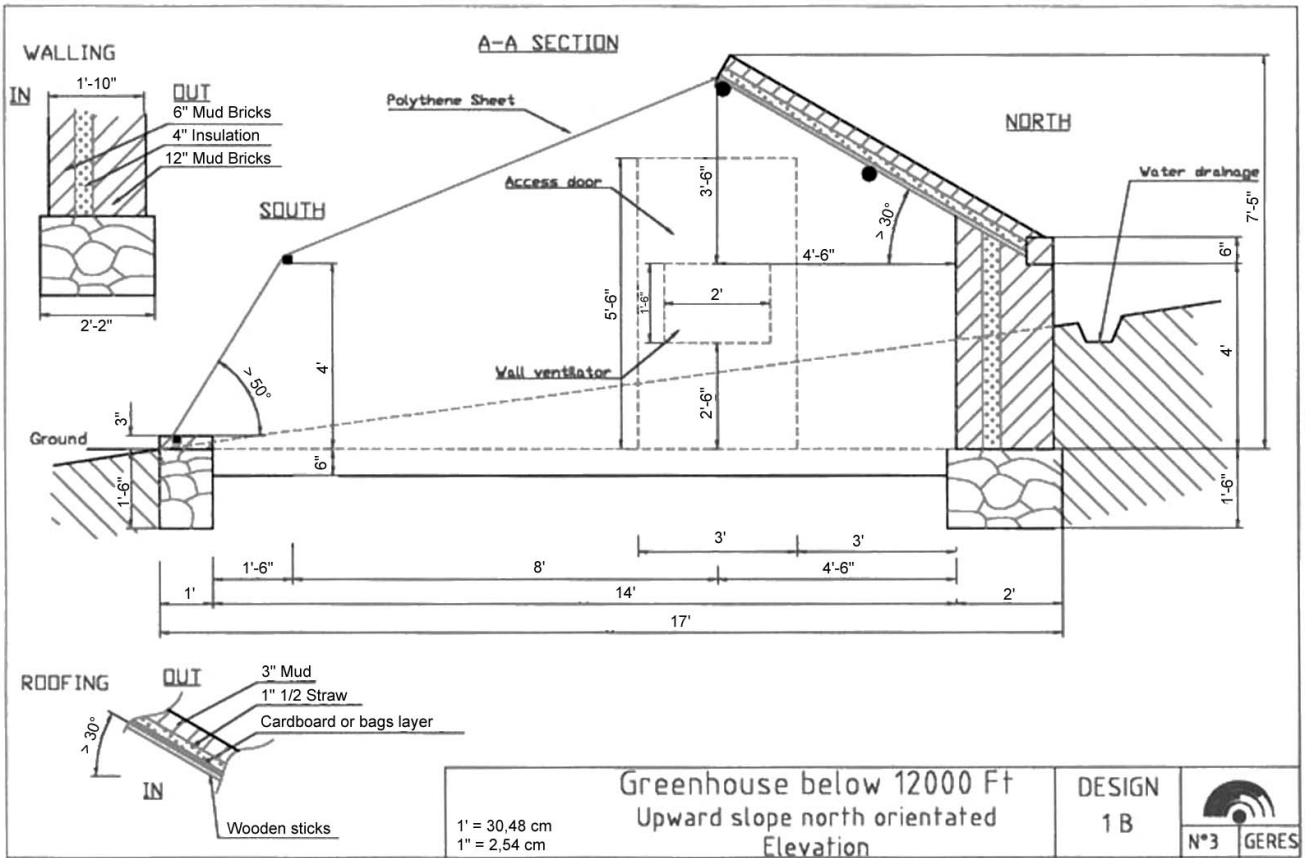

Figure 8 - Design 1B - Greenhouse below 12000 ft, Upward slope north orientated

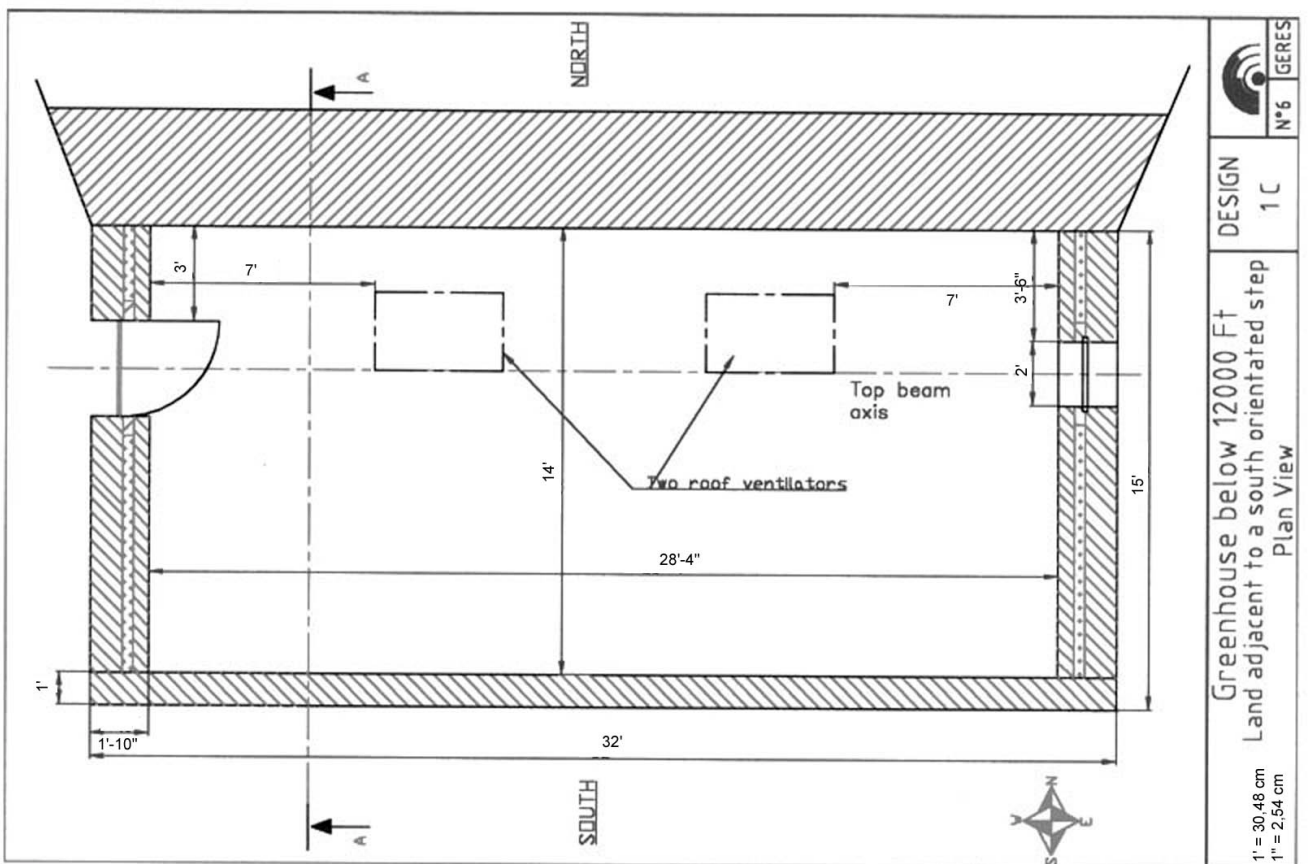
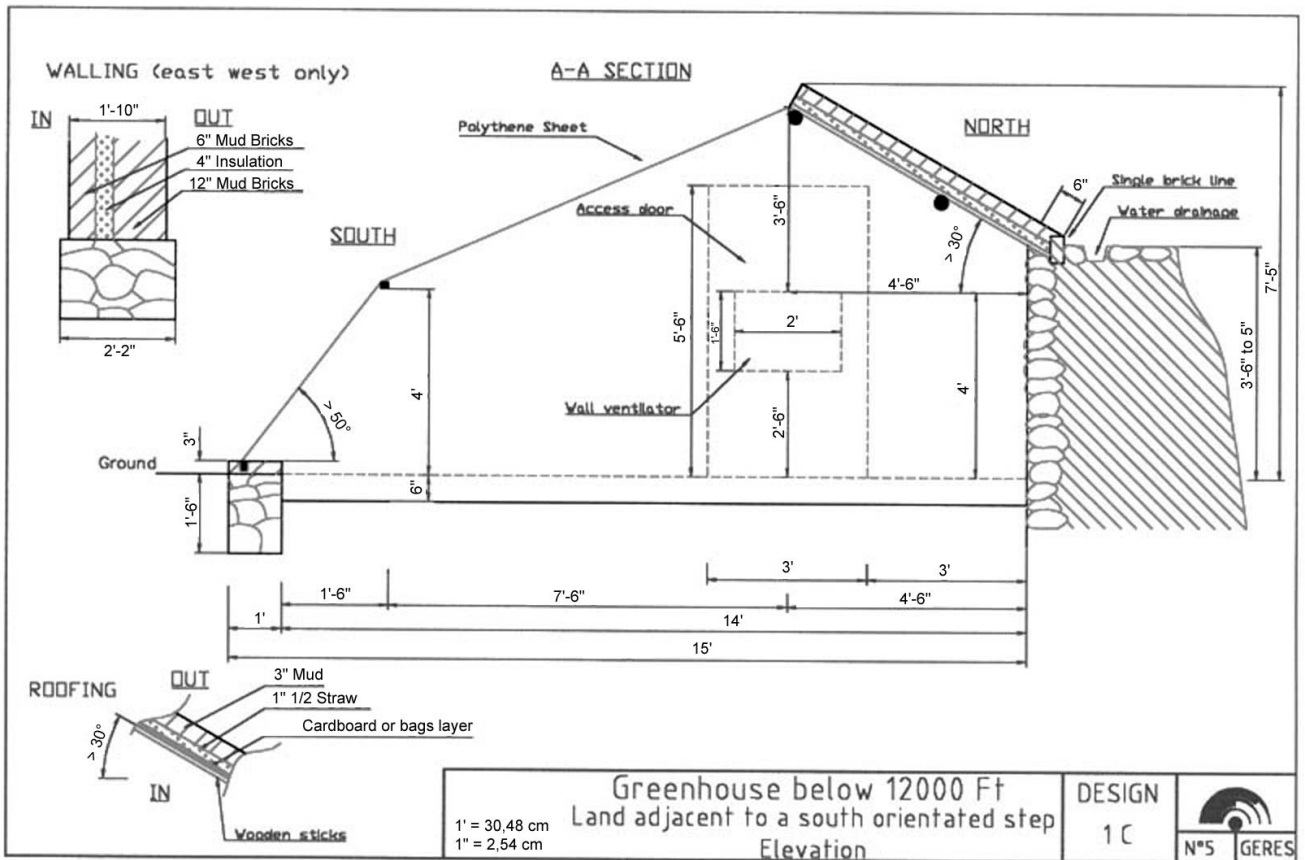

Figure 9 - Design 1C - Greenhouse below 12000 ft, Land adjacent to a south orientated step

Altitude : between 12.000 ft and 13.500 ft Design II

Design II is suitable for **the villages of Chang Tang, located between 12,000 and 13,500 ft**, such as Durbuck, Tangse and Chumatang.

Particularities :

- Roof insulation layer is increased to 2",
- Only one roof ventilator is required.

Table 6 - Characteristics for areas between 12000 and 13500 ft

CRITERIA	CHARACTERISTICS	DESIGN II DATAS
STRUCTURE	Orientation	South
	External dimensions	32 x 15 feet
	Internal dimensions	28'4" x 12'
	Door positioning	Opposite to wind
	Inner partition	No
	Roof slope	30°
	Agricultural land burying depth.	6"
INSULATION	Wall insulation	4"
	Roof insulation	2"
	Ground insulation	No
VENTILATION	Wall ventilation	Yes
	Roof Ventilation	1 roof ventilator
POLYTHENE	Single / Double	Single
	Manually operated night insulation	Yes

According to the site, select design II.A., II.B. or II.C.

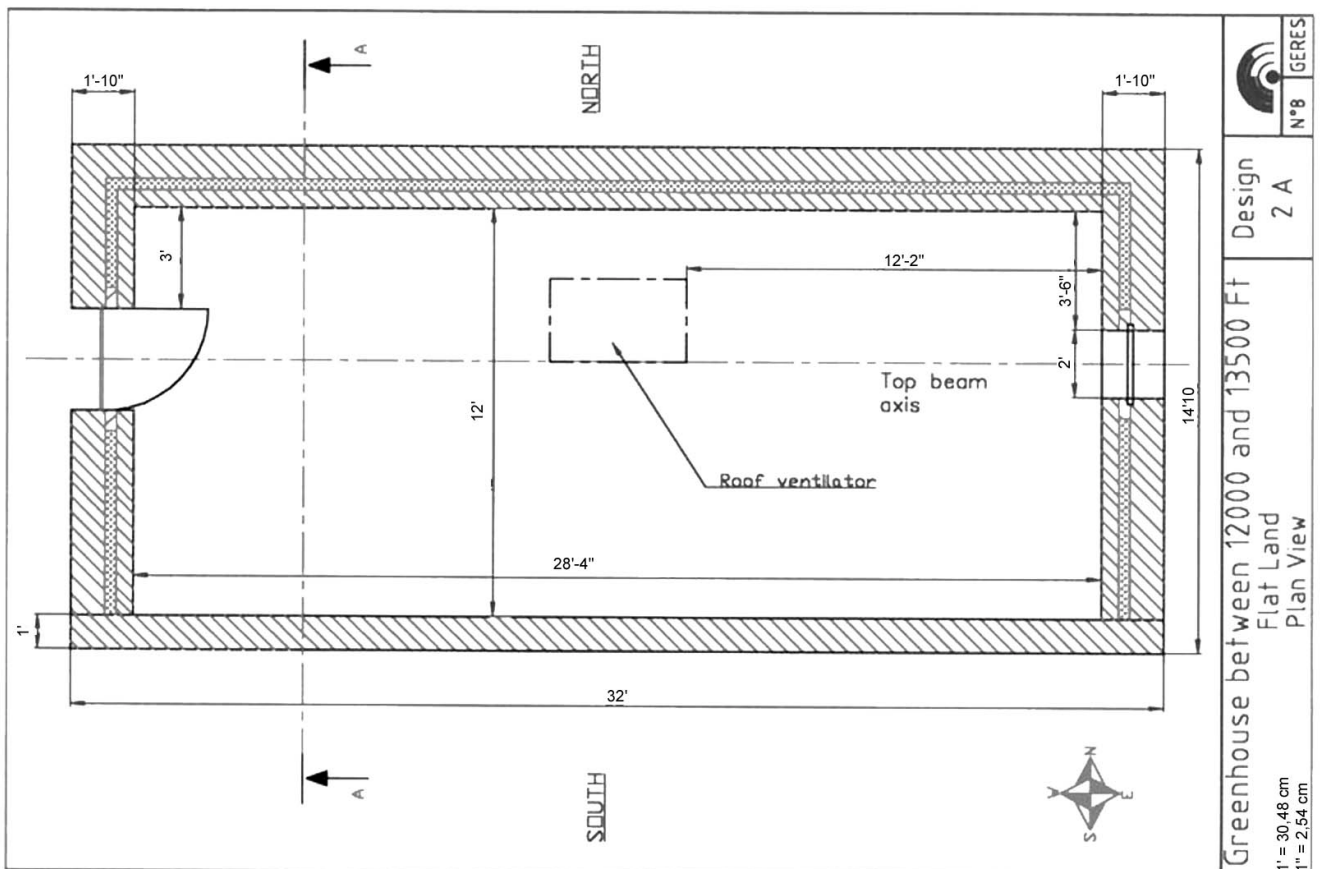
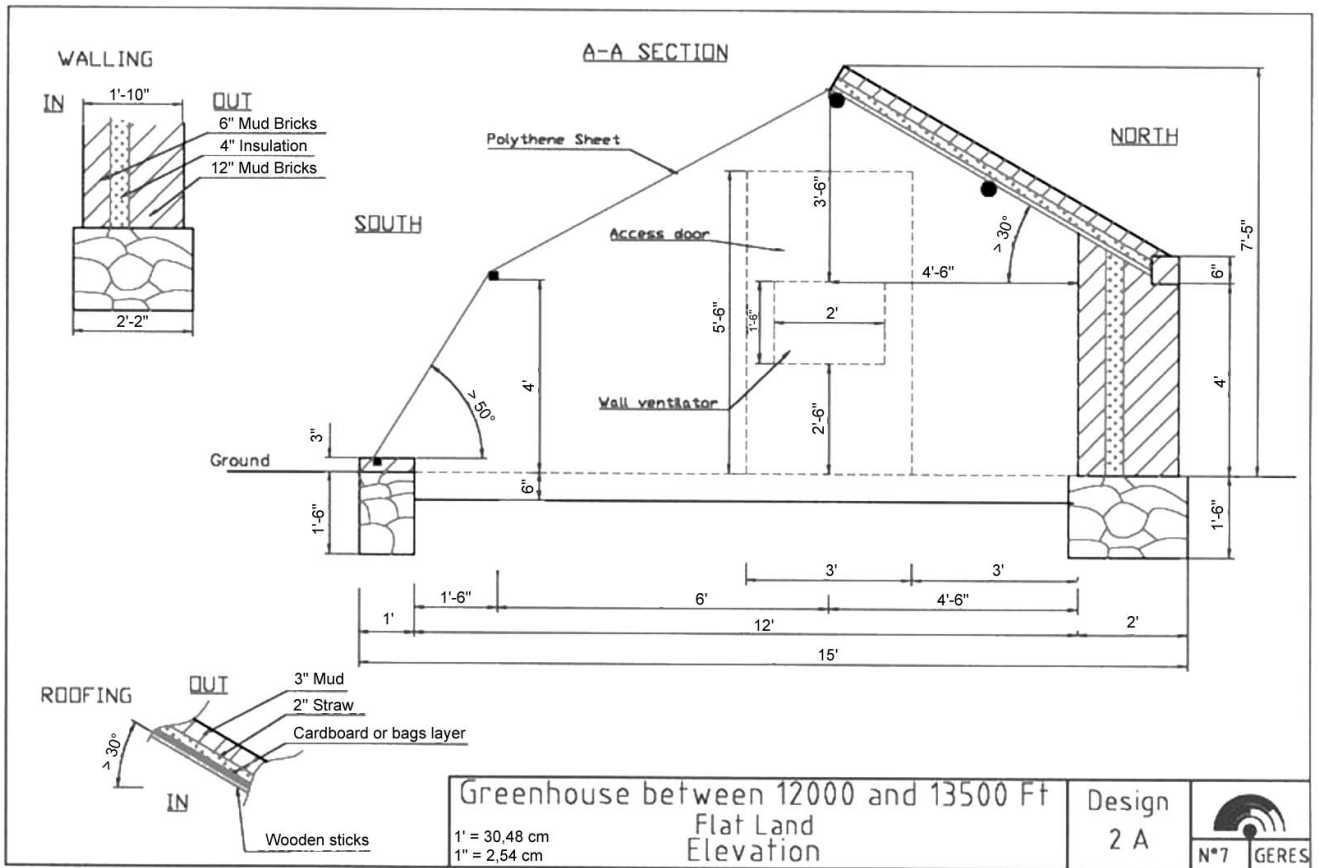

Figure 10 - Design 2A - Greenhouse between 12000 and 13500 ft, Flat land

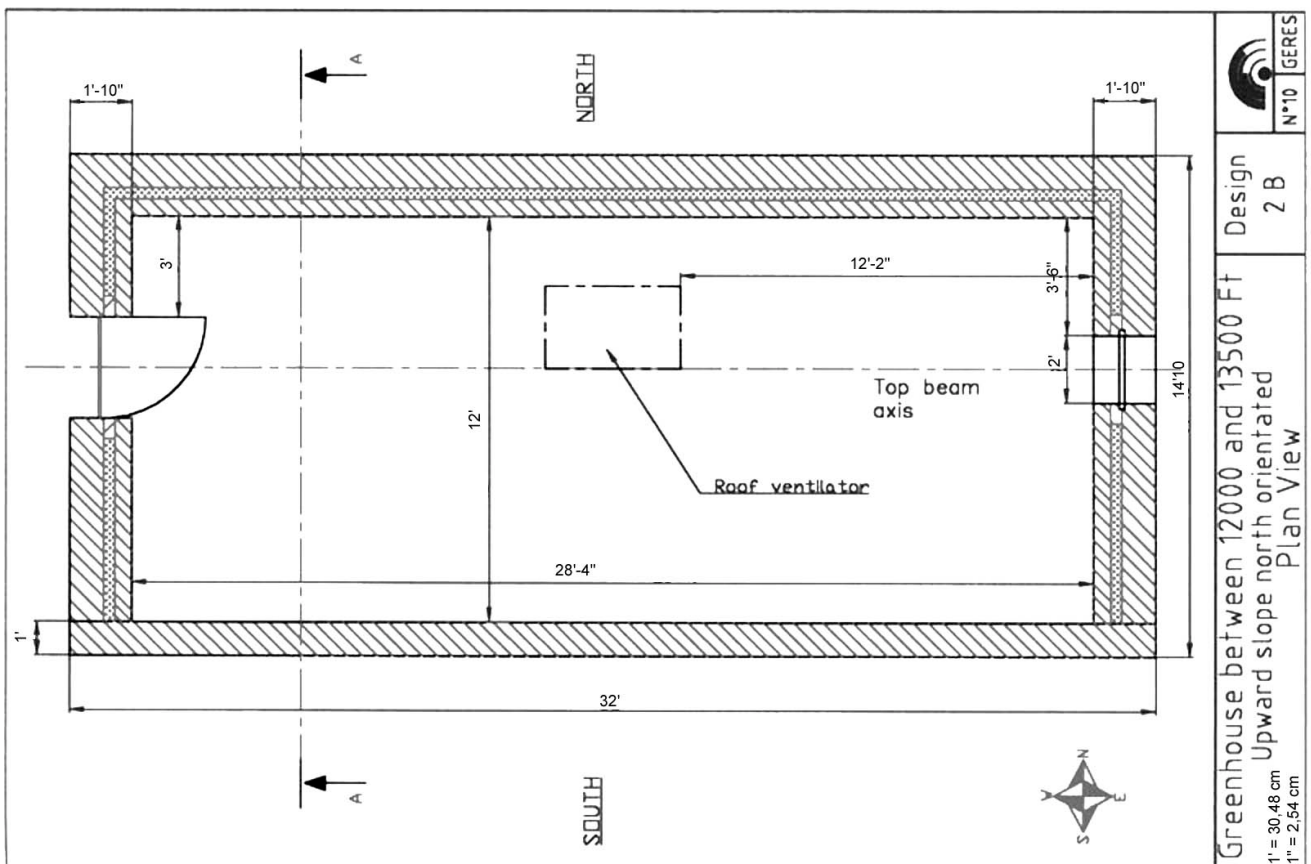
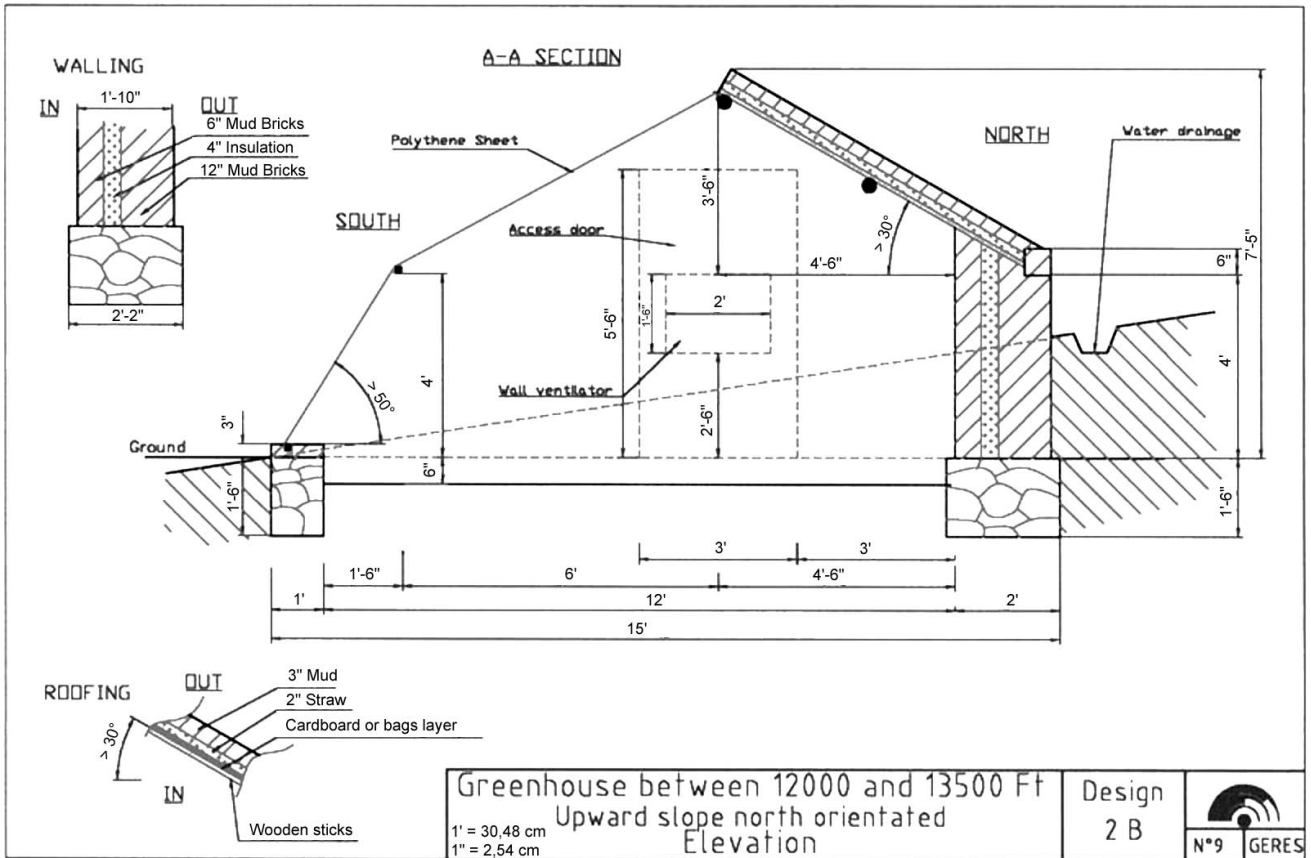

Figure 11 - Design 2B - Greenhouse between 12000 and 13500 ft, Upward slope north orientated

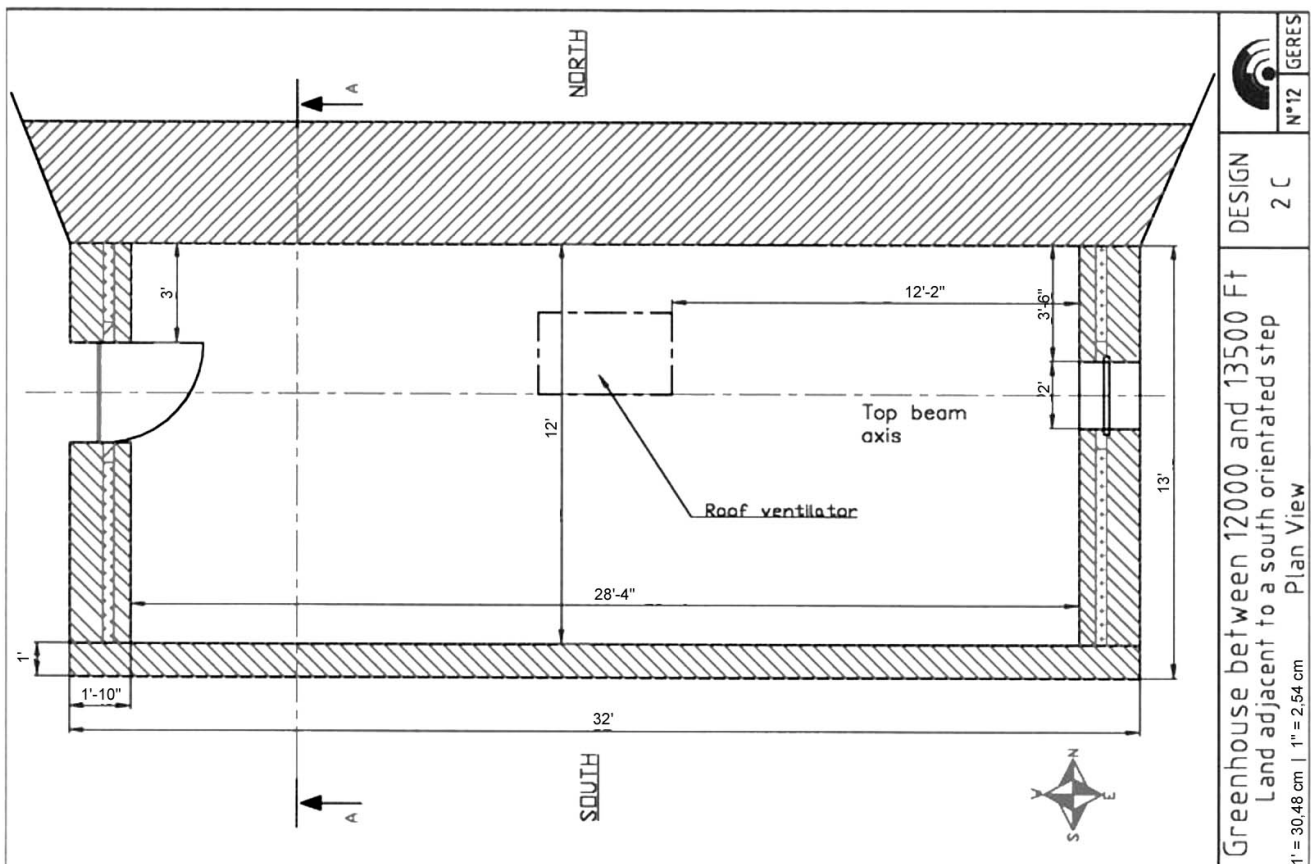
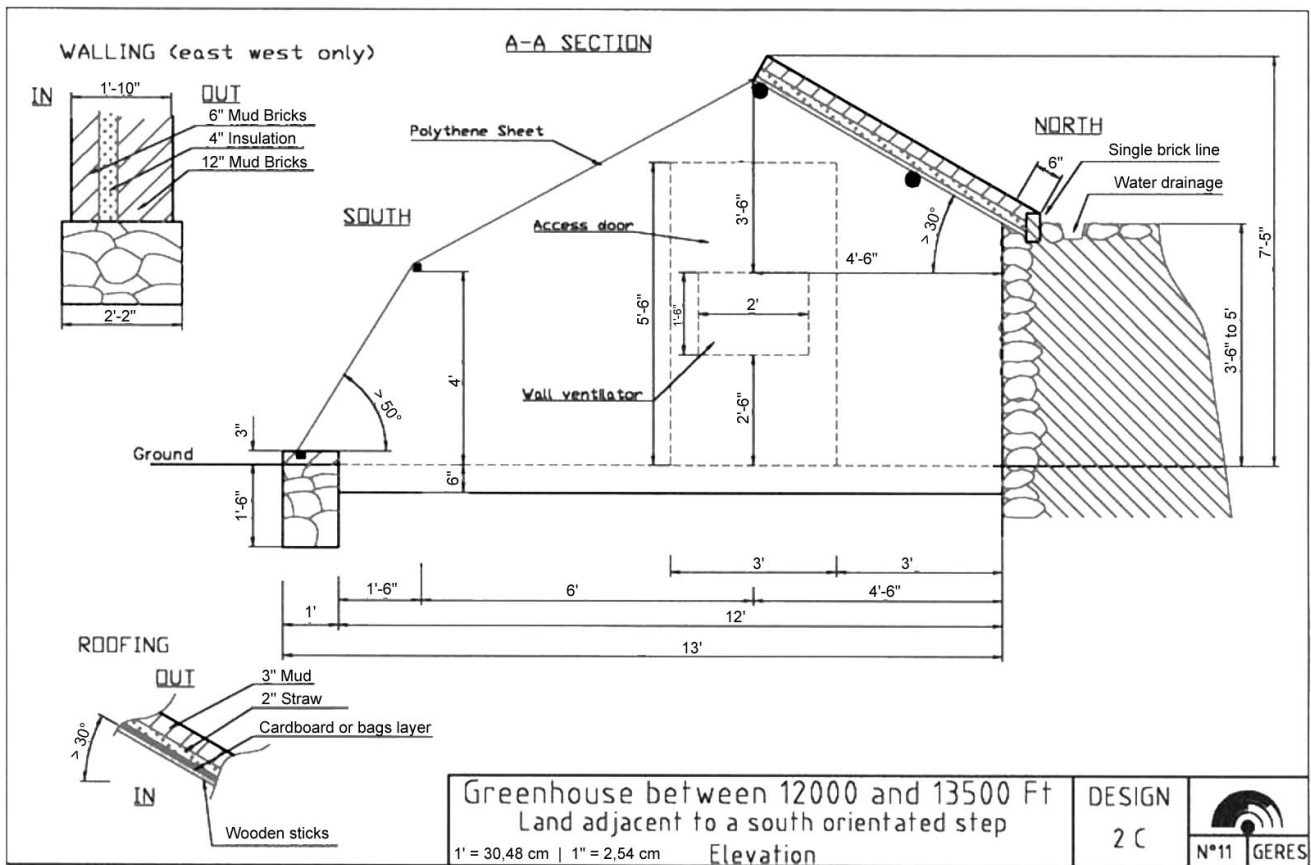

Figure 12 - Design 2C - Greenhouse between 12000 and 13500 ft, Land adjacent to a south orientated step

Design III is suitable **for the higher villages of Chang Tang, over 13,500 ft**, such as Bilasasal, Sato, Koryock.

Particularities :

- Addition of inner partition to increase thermal mass
- Double polythene is installed
- The ground is insulated,
- Only one roof ventilator is required.

Table 7 - Characteristics for areas above 13500 ft

CRITERIA	CHARACTERISTICS	DESIGN III DATAS
STRUCTURE	Orientation	South
	External dimensions	32 x 15 feet
	Internal dimensions	28'4" x 12'
	Door positioning	Opposite to wind
	Inner partition	Yes
	Roof slope	30°
	Agricultural land burying depth.	6"
INSULATION	Wall insulation	4"
	Roof insulation	2"
	Ground insulation	Yes
VENTILATION	Wall ventilation	Yes
	Roof Ventilation	1 roof ventilator
POLYTHENE	Single / Double	Double
	Manually operated night insulation	Yes

According to the site, select design III.A., III.B. or III.C.

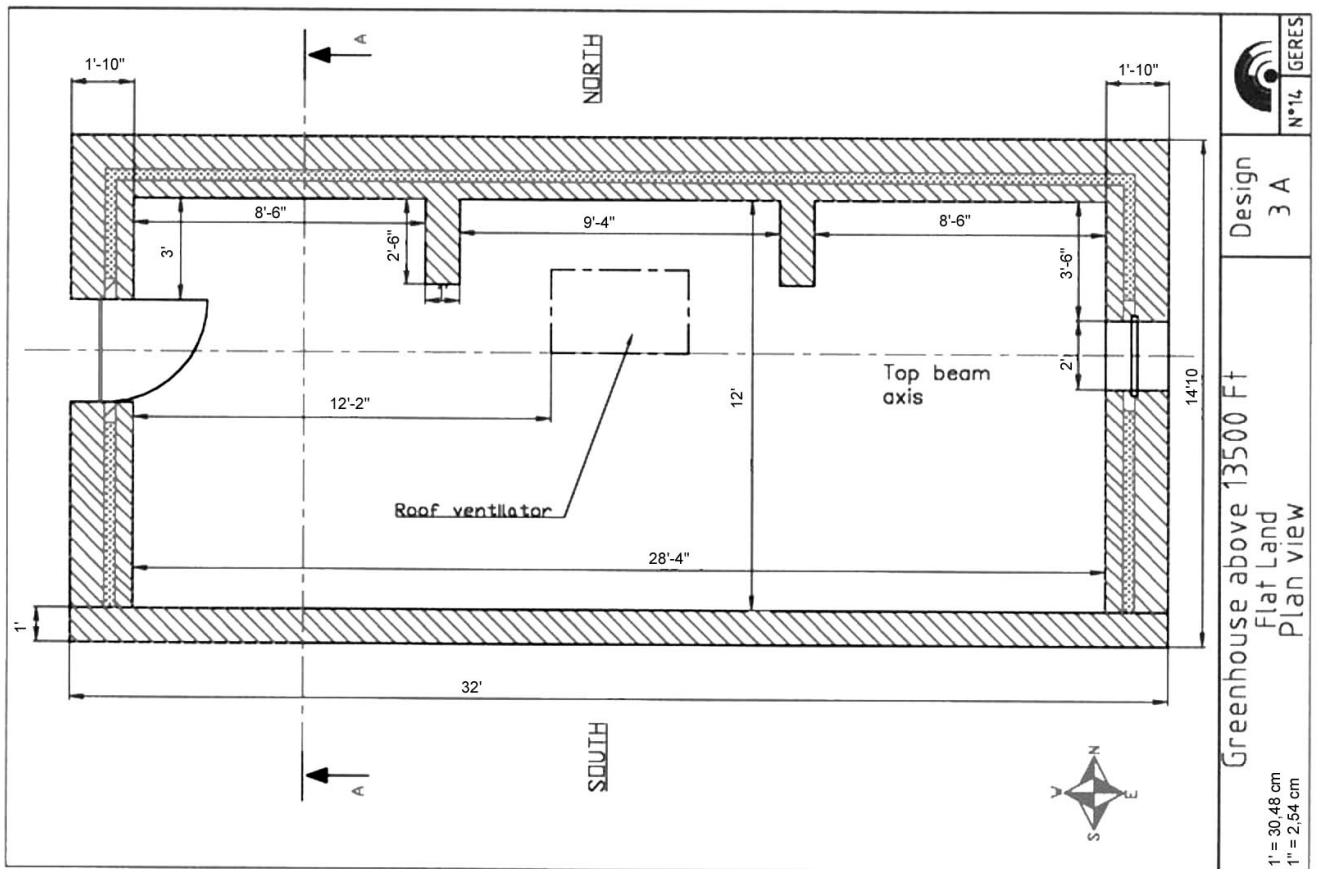
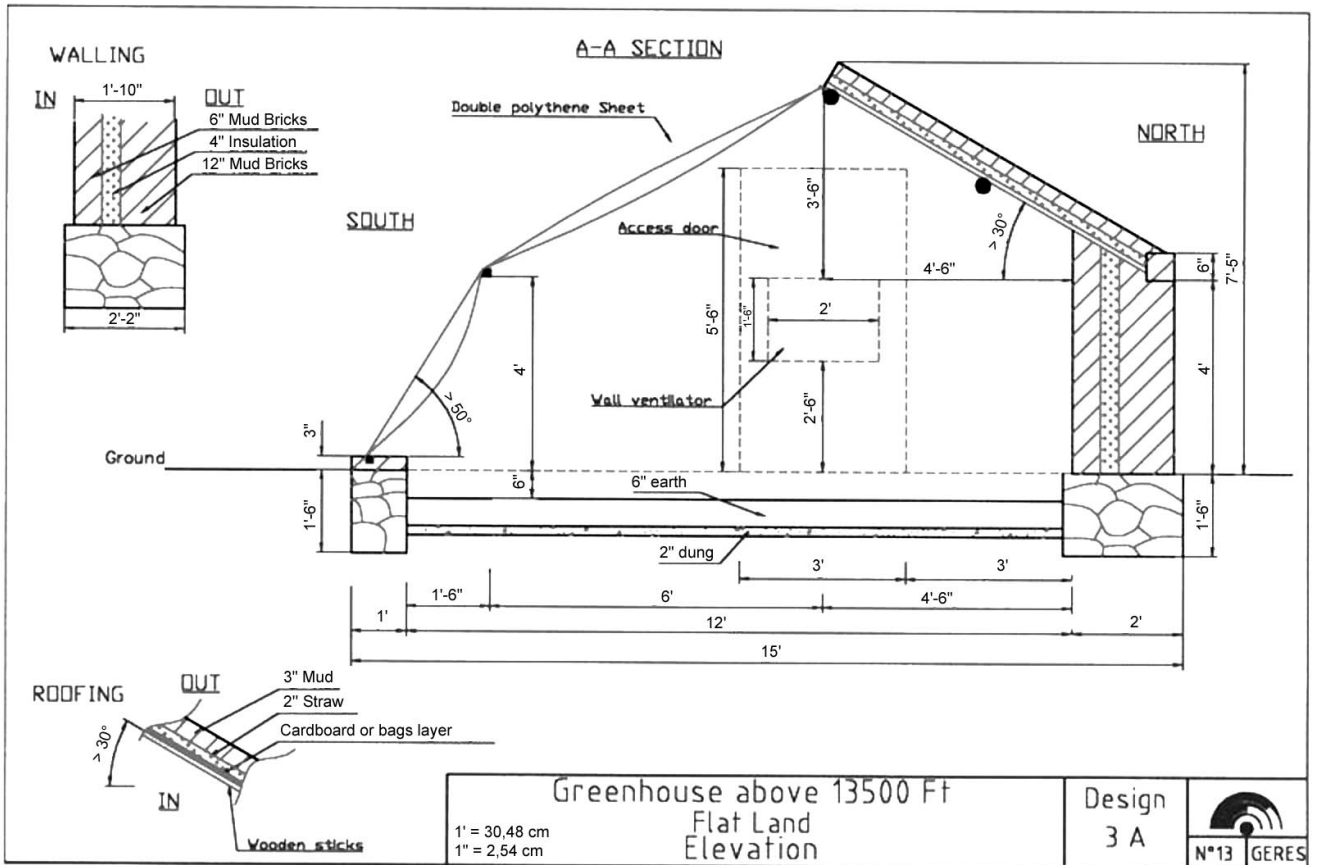

Figure 13 - Design 3A - Greenhouse above 13500 ft, Flat land

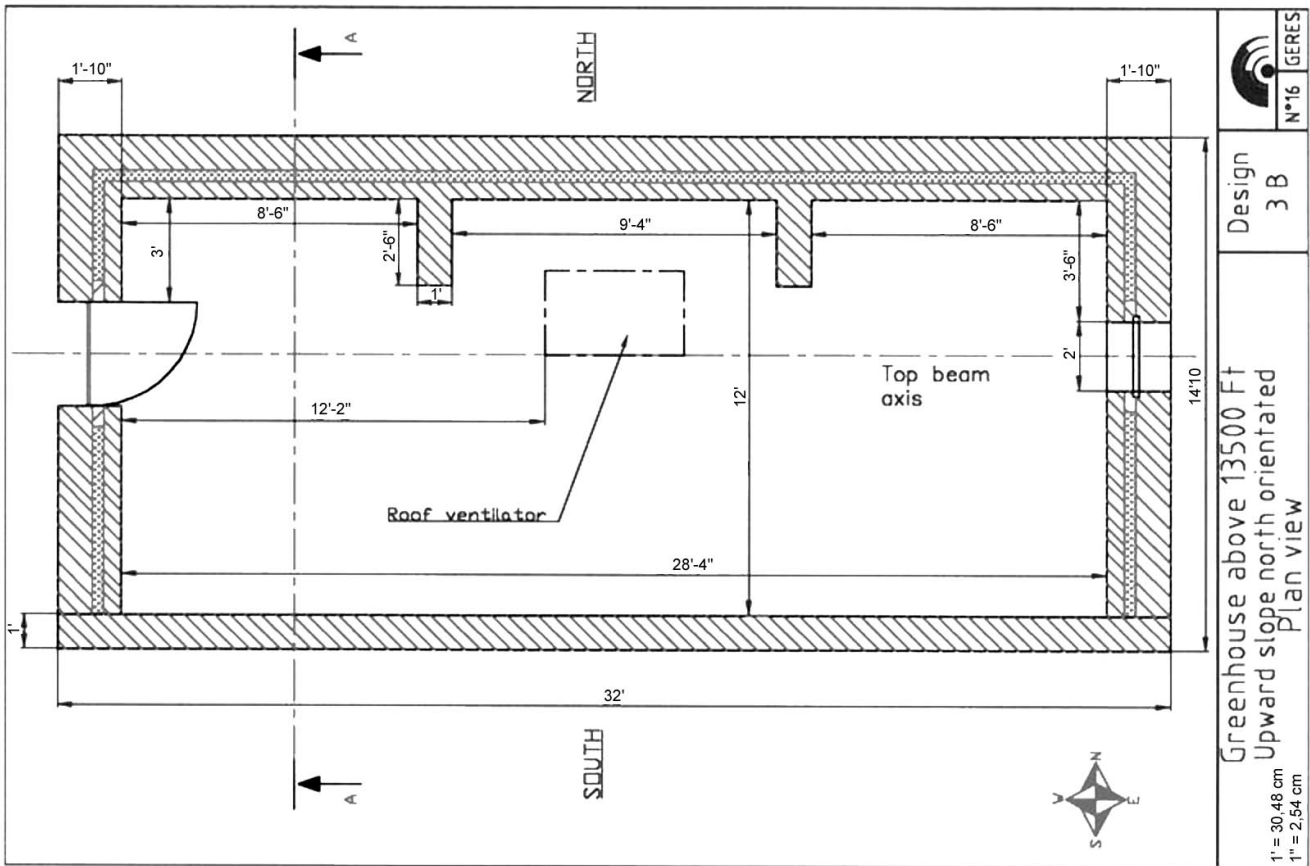
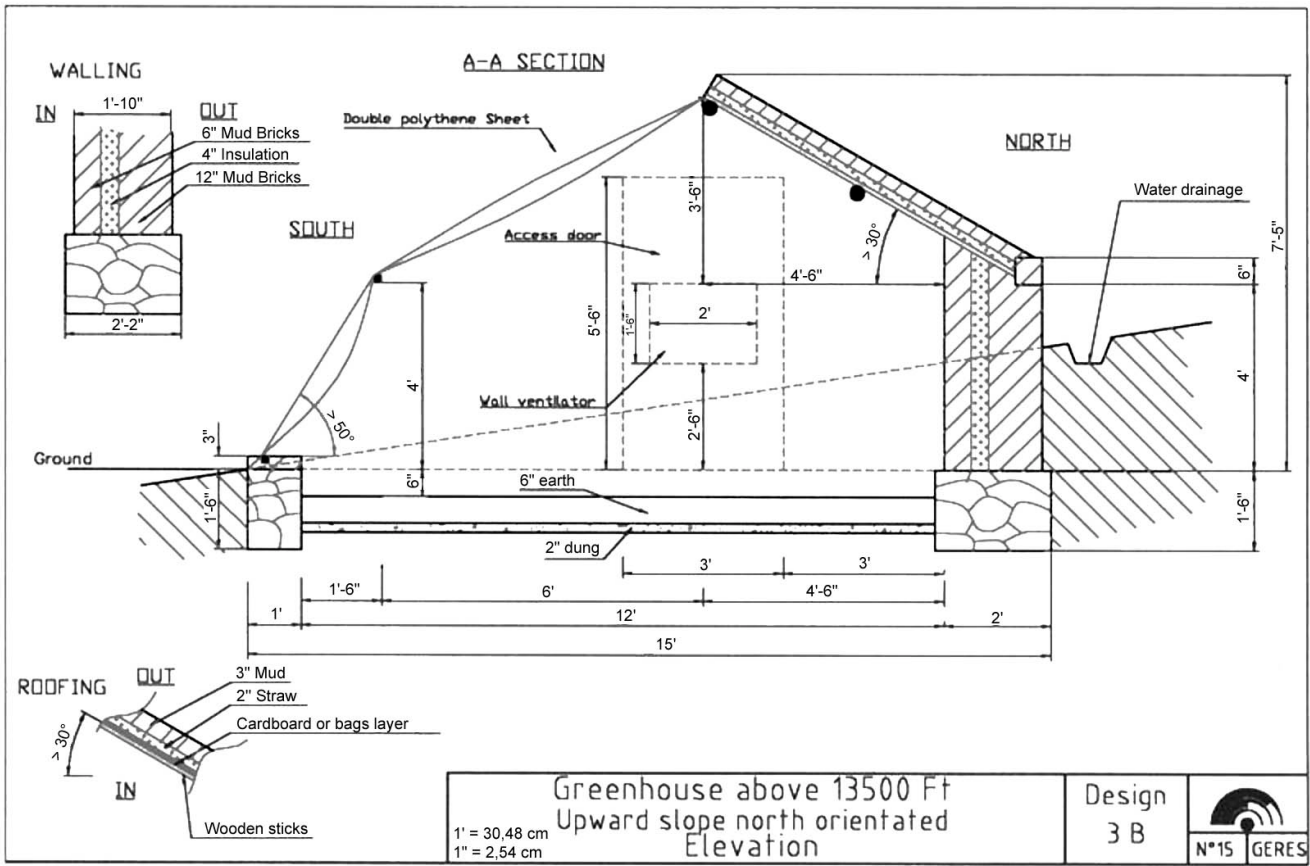

Figure 14 - Design 3B - Greenhouse above 13500 ft, Upward slope north orientated

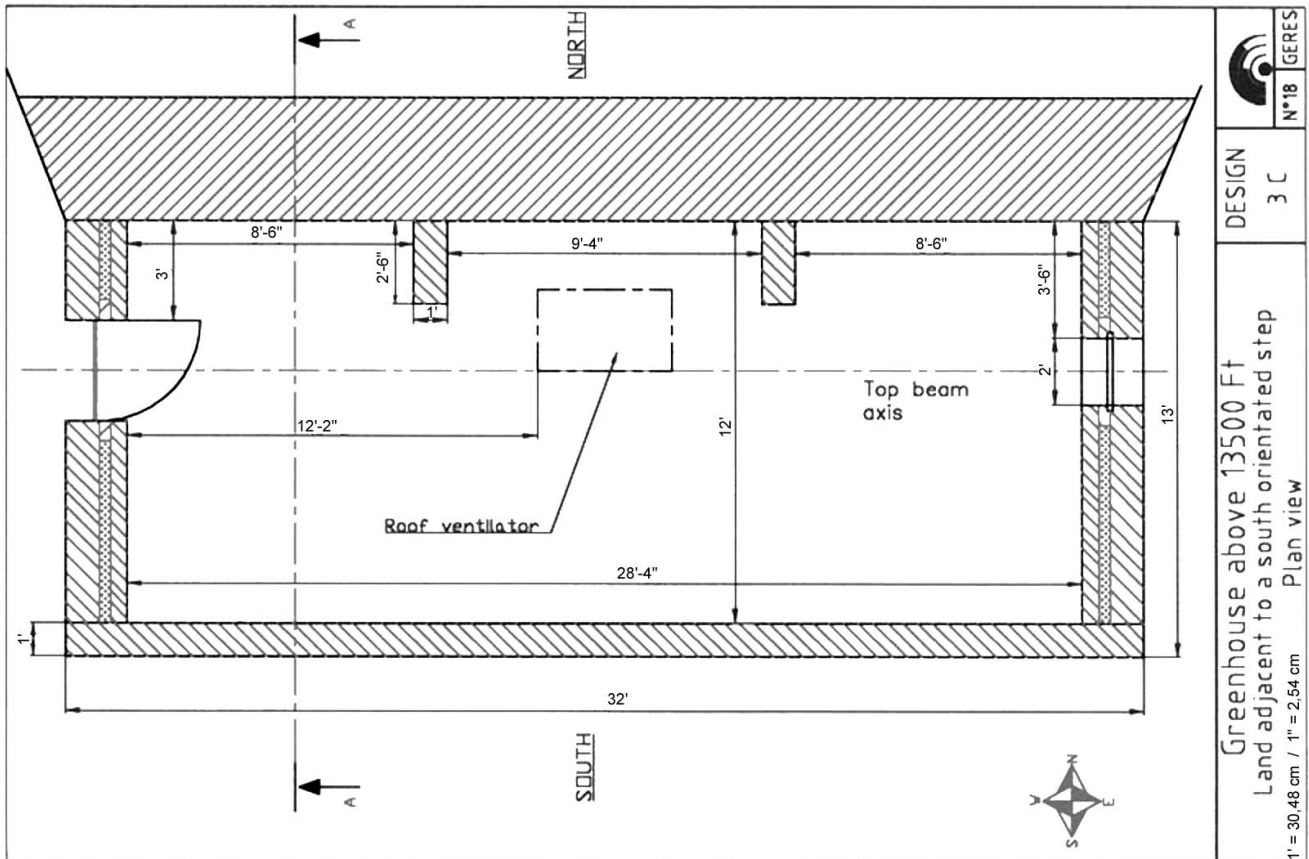
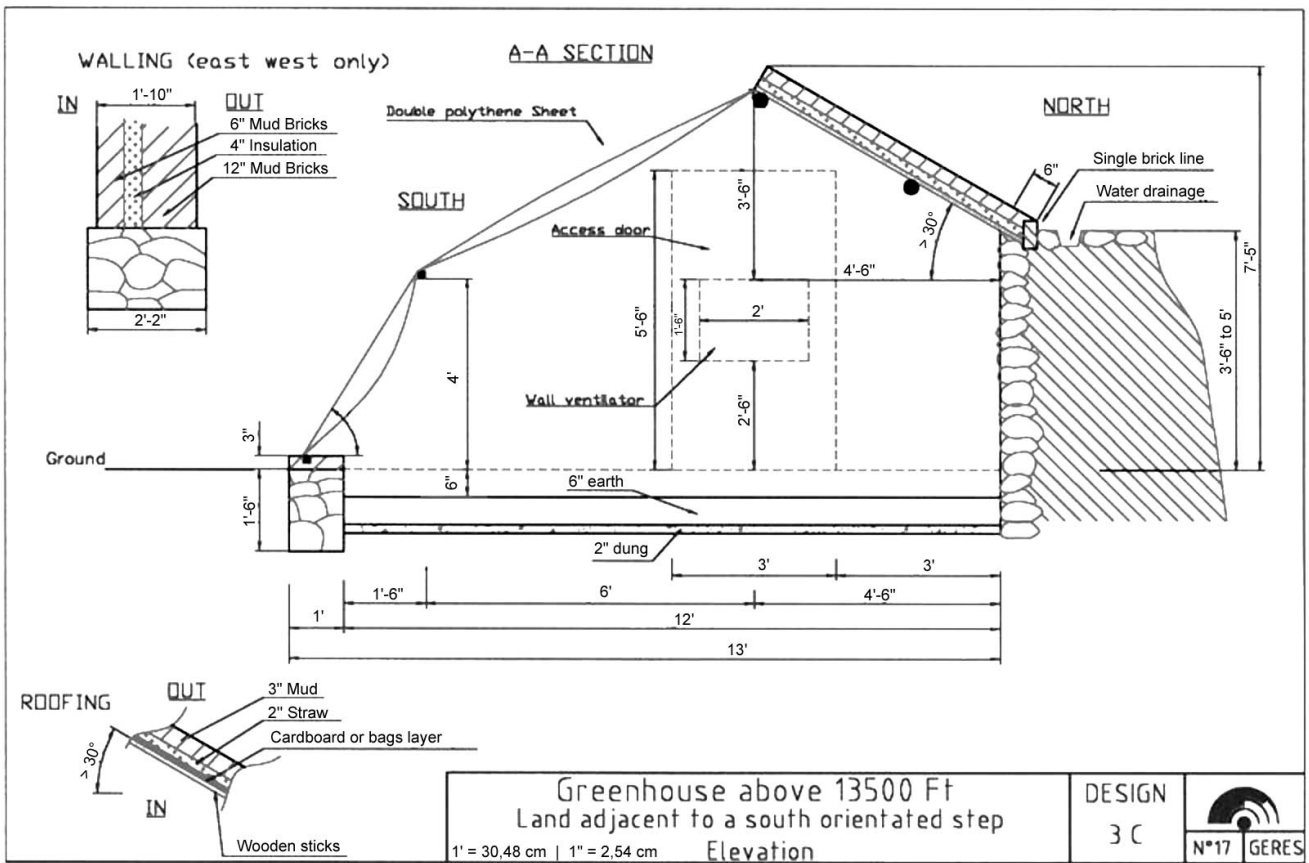

Figure 15 - Design 3C - Greenhouse above 13500 ft, Land adjacent to a south orientated step

Design IV is suitable for **snowy areas**.

Particularities :

- Roof and polythene slope are increased to 40° so that snow can slide off it on both sides,
- A double polythene is installed,
- Only one roof ventilator is required.

Table 8 - Characteristics for snowy areas

CRITERIA	CHARACTERISTICS	DESIGN IV DATAS
STRUCTURE	Orientation	South
	External dimensions	32 x 14 feet
	Internal dimensions	28'4" x 11'
	Door positioning	Opposite to wind
	Inner partition	No
	Roof slope	40°
	Agricultural land burying depth.	6"
INSULATION	Wall insulation	4"
	Roof insulation	2"
	Ground insulation	No
VENTILATION	Wall ventilation	Yes
	Roof Ventilation	1 roof ventilator
POLYTHENE	Single / Double	Double
	Manually operated night insulation	Yes

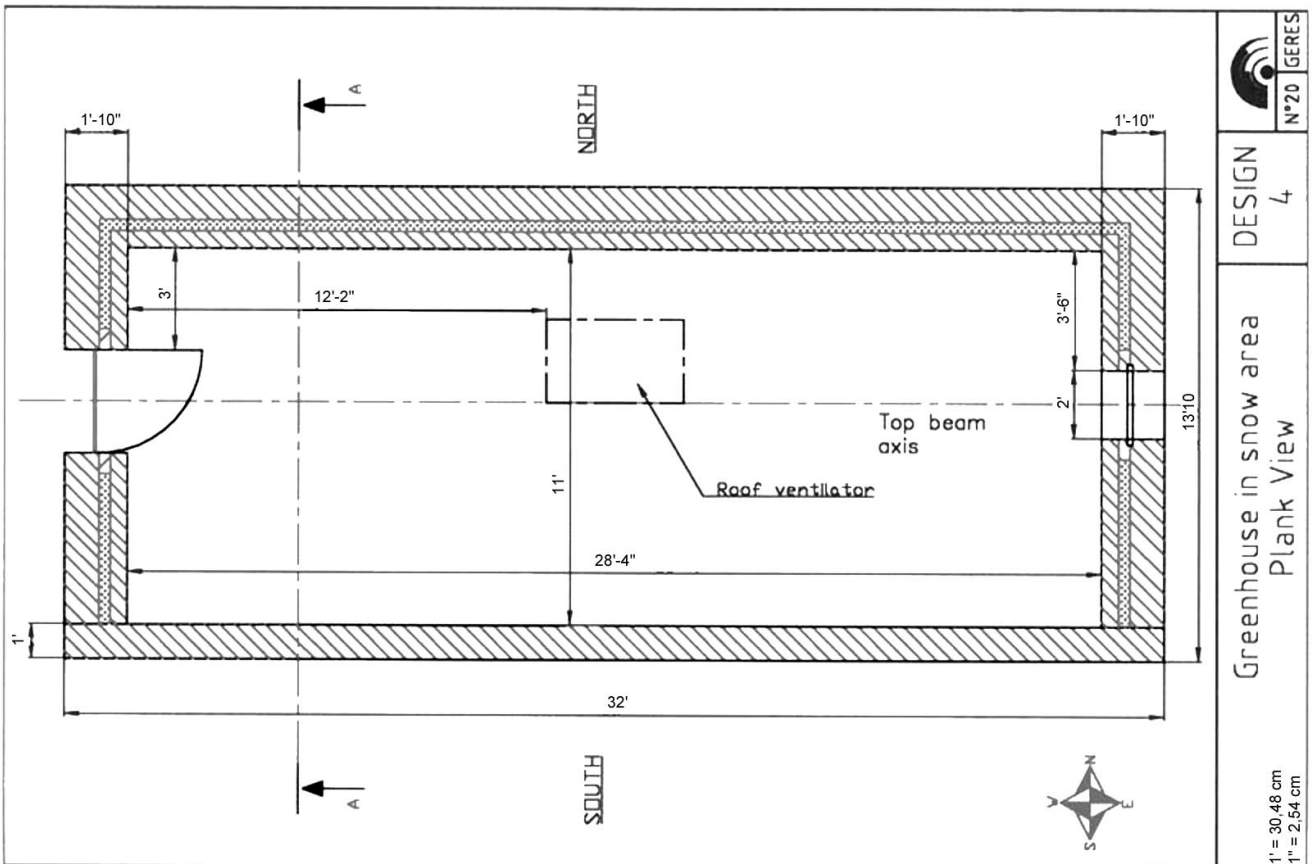
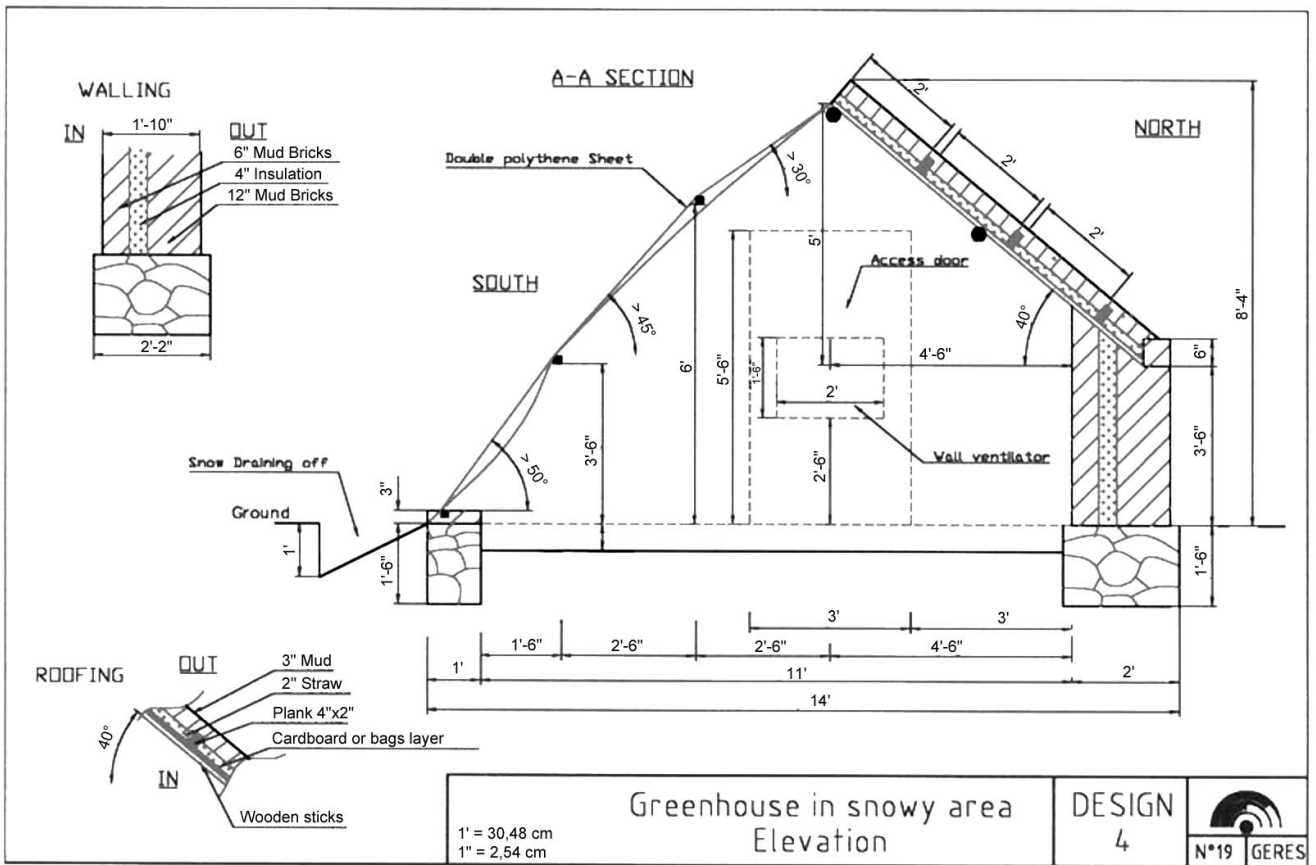

Figure 16 - Design 4 - Greenhouse in snowy areas

Bibliography

Passive solar

- **Mazria, Edward**, 1979. The Passive Solar Energy Book. Rodale Press, Emmaus, PA. 435 p.
- **Levy Emanuel**, The Passive Solar Construction Handbook: Featuring Hundreds of Construction Details and Notes, Materials Specifications and Design Rules of Thumb
- **Shapiro, Andrew**. 1985. The Homeowner's Complete Handbook for Add-On Solar Greenhouses and Sunspaces. Rodale Press, Emmaus, PA.
- **Sanjay Prakash**. 1991. Solar architecture and earth construction in the Northwest Himalaya, Development Alternatives, India. 132p.
- **J.D Balcomb**, 1981, Heat storage and distribution inside passive solar buildings, Los Alamos National Laboratory,; New Mexico, USA, 112p.
- **A Guinebault** and **J.F. Rozis**. 1997. Passive solar heating in cold area, , GERES, Fr. 192p.
- **V. Stauffer** and **D.Hooper**. 2000. A training manual on passive solar. GERES, Fr. 40p

Greenhouse construction

- **Anon**. 1980. A Solar Adapted Greenhouse Manual and Design. Miller-Solsearch, Charlottetown, PEI, Canada.
- **Anon**. 1984. Building and Using the Solar Greenhouse. Alabama Solar Energy Center, Huntsville, AL. 41p.
- **Alward, Ron** and **Andy Shapiro**. 1981. Low-Cost Passive Solar Greenhouses. National Center for Appropriate Technology, Butte, MT. 173p.
- **Kramer, Jack**. 1980. Your Homemade Greenhouse. Cornerstone, New York. 95p.
- **McCullagh, James C.** (ed.) 1978. The Solar Greenhouse Book. Rodale Press, Emmaus, PA. 328p.
- **Aldrich, Robert A.** and **John W. Bartok, Jr.** 1989. Greenhouse Engineering. NRAES-33. Cornell University, Ithaca, NY. 203p.
- **Geery, Daniel**. 1982 . Solar Greenhouses: Underground. TAB Books, Blue Ridge Summit, PA. 400p
- **Fuller, R.J.** 1992. Solar Greenhouses for the Home Gardener. Victorian Dept. of Food and Agriculture, Melbourne, Australia. 27p.
- **Fisher, Rick** and **Bill Yanda**. 1976. The Food and Heat Producing Solar Greenhouse: Design, Construction, Operation. John Muir Publications, Santa Fe, NM. 161p.
- **Freeman, Mark**. 1997. Building Your Own Greenhouse. Stackpole Books, Mechanicsburg, PA. 208p.
- **Bartok, John W.**, and **Susan Mackay**. 1982. Solar Greenhouses for the Home. Northeast Regional Agricultural Engineering Service, Cornell University, Ithaca, NY. 60p.
- **Parsons, R.A., et al.** 1979. Energy Conservation and Solar Heating for Greenhouses. Northeast Regional Agricultural Engineering Services, Cornell University, Ithaca, NY. 47

Greenhouse running

- **Kemble, Keith**, and Peggy Todd. 1985. Managing Your Solar Greenhouse. Dept. of Natural Resources and Conservation, Helena, MT. 48p.
- **Murray, Ian**. 1993. Practical Greenhouse Gardening. Crowood Press, Ramsbury, Malborough, Wiltshire, U.K. 63p.
- **Williams, T. Jeff**, **Susan Lang**, and **Larry Hodgson**. 1991. Greenhouses. Ortho Books, San Ramon, CA. 112p.
- **Christophe Viltard**. 2003. A Manual of Solar greenhouse running inn Trans Himalayas. GERES, Fr. 65p.

PART B

**TECHNICAL GUIDELINES TO BUILD A
GREENHOUSE**

Introduction to the construction schedule

Part B aims to give technical guidelines to assist people to build a greenhouse the most efficient way. These guidelines are submitted as simple datasheets that follow chronologically the construction of a greenhouse.

Before construction

Before construction, and according to the method explained in Part A, select :

- the best site
- the suitable design

The construction

Once all the material has been collected, the construction can start. The different steps are:

- The drawing of foundation lines (*see technical datasheet 1*),
- Foundation digging,
- Filling the foundations with stones,
- Wall construction (*see technical datasheet 2*) with the installation of the door (*see technical datasheet 3*) and the wall ventilator (*see technical datasheet 4*),
- Filling the air gap of the double wall with insulation (*see technical datasheet 2*),
- Installing an internal partition if required (*see technical datasheet 5*),
- Roof construction (*see technical datasheet 6*),
- Plastering, white washing and the painting (black) of the required part of the wall (*see technical datasheet 2*),
- Construction of the wooden frame supporting the polythene (*see technical datasheet 7*),
- Installation of polythene (*see technical datasheet 7*),
- Installing of roof ventilator (*see technical datasheet 8*),
- Providing night insulation (*see technical datasheet 9*).



Picture 10 - A team constructing a greenhouse in Qinghai

Technical Datasheet N°1: Drawing foundation

Principle:

Foundations are the basis of every structure. The orientation must be carefully drawn to respect the appropriate designs in order to allow maximum efficiency.

Principals knowledge:

Find the south :

The efficiency of a greenhouse is directly linked to its geographical orientation. **A greenhouse must be south faced.** Depending on the agricultural land configuration, the difference with the exact south can 10° toward East or West to save agricultural land. Thus, to place the “south side” of the greenhouse exactly in the south direction you can:

- **Use a compass** : in the Hindu-Kush-Himalaya range, the magnetic north is nearly similar to the geographic north (+/- 5°). Draw on the ground the south face line using a rope parallel to the East-West axis given by the compass.
- **Use the “plumb-line” method.** For this method you will need a stone linked to a rope and a clock. In Ladakh, when the clock indicates 20 past 12 (12:20 P.M.), hang the rope in your hand. The shadow of the rope will draw a line on ground : this line is the North-South axis .

Now you can draw on ground the four cardinal points: *North, East, South,* and *West* as shown on picture 11. Draw the south face, the East-West axis, on ground by means of a rope.



Picture 11 - View of south tracing by means of “plumb-line” method



Picture 12 - “3, 4,5 method”

Draw a right angle:

One of the most important basis in wall construction is to get them perpendicular, that is to say, manage to form a right angle between walls.

To do so, you can use two method: the “3,4,5 method” and the “bisecting lines method”

- Use the “3,4,5 method”: When south face has been drawn on ground, install a rope from a point, at one extremity of south face. Follow south face direction for 3 feet. Fix the rope with little posts

Then, unroll a tape for a 9 feet length from the first point. Join the extremity of the unrolled tape to extremity of the 3 feet rope.

Finally, improve the positioning of the walls by trying manually to reach a 4 feet length perpendicular to south side. You should now obtain a triangle : 3 feet on south side, 4 feet on the perpendicular and 5 feet on diagonal. See picture 12.

Repeat for each wall positioning

- Use bisecting lines method:

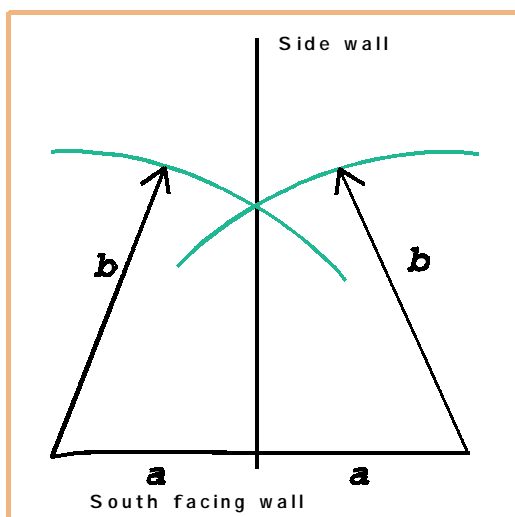

- From one extremity of south face, draw two lines of same length (a) in two opposite directions.
- Then, from each end of the two lines draw an arc of a circle of radius b
- The intersection of those arcs is a point that, linked to the first point, will give the direction of the side wall, perpendicular to south face.

Note : For greenhouses above 13500 feet, please refer to Datasheet N°5 for partition wall positioning.

Figure 17 - Bisecting lines method to draw a right angle

Building and strengthen the foundations

If the upward part of the land is towards the north, the excavation of the land is first step (picture 13). In the 3 configurations (flat, slope, terrace), after digging the foundation, fill the cavity with loose stones. Then a 2 inch thick layer of concrete on the top of the foundation can strengthen the structure of the greenhouse and reduce the risks of dampness (picture 14).



Picture 13 - Excavation of the slope



Picture 14 - A 2 inch thick layer of concrete at the top of the foundations

Technical Datasheet N°2: Building a double wall

Forming the shape / Controlling the angles of the walls:

As shown in greenhouses designs, the east and west walls are built according to a particular shape, following precise angles.

To do so, “draw” the shape by means of stakes driven into the ground and rope (picture 15). The rope is knotted around the stakes and should draw the shape of the finished wall. The wall can then be constructed up to the level of the rope (picture 16).



Pictures 15 & 16 - Forming the shape with a rope (in Qinghai and Ladakh)

The double wall is composed of 3 vertical layers (picture 19):

- an external load bearing wall built with mud brick (12”), rammed earth or stone.
- an insulation layer (4”)
- an internal thermal storage wall built with mud brick (6”).

If mud bricks are not available, the internal wall can also be built with rammed earth or stone but the foundation width will be increased and the greenhouse will be more expensive.

In some particular cases, such as in Qinghai where the quality of the soil is poor, the 4" thick outer wall is build with baked bricks to protect the wall from the rain. The 12" thick inner wall is constructed with rammed earth stabilised by 5% cement to increase the thermal mass (see picture 18) . In Spiti (India), where the clay content of the soil is high, skilled masons are able to construct the double wall using a single frame with inside two layers of rammed earth (2x 8" thick) taking in sandwich a 4" layer of straw!!!



Picture 17 - Building of double wall with mud bricks in Ladakh



Picture 18 - Construction of the outer wall with baked bricks and the inner wall with stabilised rammed earth in Qinghai

Simultaneous building of the external wall and the inner wall.

(excepted with stone or rammed earth walls which must be constructed first)

The gap between the inner and external wall can be reinforced with sticks every 8' long and 2' high (picture 19).

First, chop seabuckthorn or any other thorn in 4 to 6 inch lengths stems and mix them with insulator.

Fill the lower 1'6" of the gap with this mix. They aim to protect the greenhouse from rats and mice. A mix of chopped "water grass" and chopped seabuckthorn can limit the moisture problem arising from the ground water

Then fill the air gap remaining with insulation material, compress them a little bit using a stick and then complete up to the top with insulation material without compressing it.

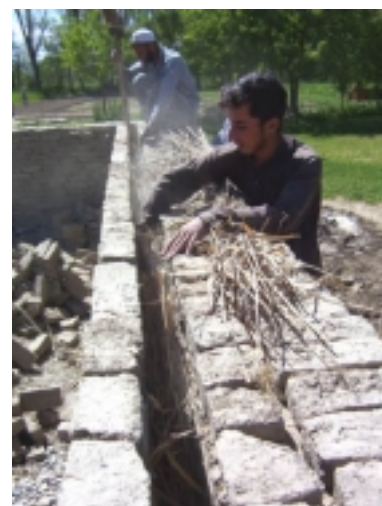

Picture 19 - View of double wall and insulation filling (sticks are added to reinforce the gap)

The suitable insulation materials are:

- Straw (long stems)
- machine straw (short stems cut by machine)
- yagzee
- wild bush
- horse or donkey dung
- saw dust
- wood shavings



Picture 20 - View of suitable insulation materials

Finish the wall by covering the insulation layer with mud. A banked earth can be added on external periphery of the walls to reduce the heatloss trough the foundations.

Note : If the greenhouse is built above 13500 feet, partition walls must be built, according to datasheet 5.

Painting :

Plaster the external and inner side of the walling. The walls have to be very smooth so that they can be white washed or black painted (picture 21).

The inner side of the west wall is white washed to reflects the morning radiation to the vegetables.

The inner side of the north wall and the inner side of the east wall are painted black to store the solar radiation.

The black paint can be made with :

- A mix of oil and ashes
- Powder paint



Picture 21 - View of white washed west wall and black painted north wall.

Building drawing:

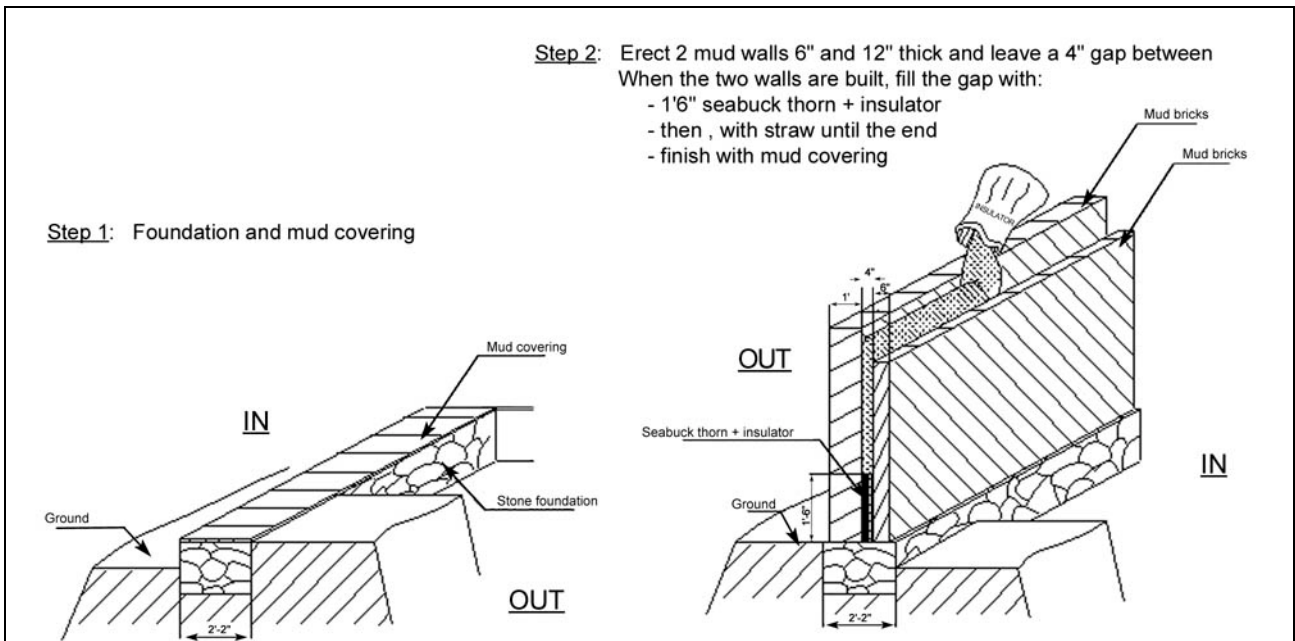

Figure 18 - Double wall construction.

Technical Datasheet N°3: Installing an access door

Part I: Carpentry

Making the doorway frame:

- Prepare wooden beams painted with oil (to make them moisture resistant) , section 4"x3"
- Cut the inner edges as shown in figure 20.
- Fix them in order to obtain a rectangular frame (external dimension 5'6"x3').

Making the door (figure 19):

- Select good quality wood, section at least 2"x1"1/2,
- Build the frame of the door with wooden battens so that the external dimensions are 5'2" high, 2'8" wide.
- Fill the spaces with insulating material as shown in picture 22,
- In the middle of the frame, nail an other wooden batten along the width of the frame which will reinforce it.
- Then prepare a piece of plywood 2'8"x5'2" and nail it to the assembled frame. Nail a plywood plate on the other side.



Picture 22 - Door construction

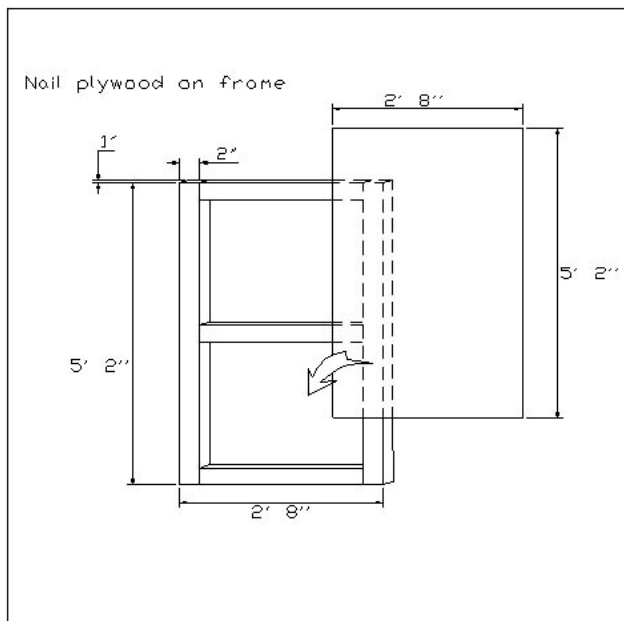

Figure 19 - Door frame

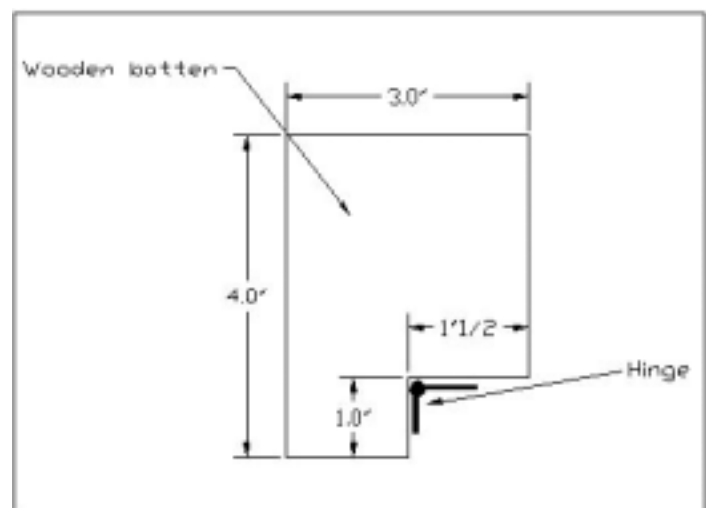

Figure 20 - Doorway frame

Now place hinges so that you can rotate the door around the doorway frame.

Part II: Masonry - Installation procedure

- Find the correct location for the door while the foundation are being drawn and built. It must be placed at 3' from the interior of the north wall (figure 23),
- Install the doorway frame in the middle of the load bearing wall width (1' wide wall),
- Start to build the wall as explained in the double wall technical data sheet N°2, but be careful **to put mud bricks along the door** opening to sustain it (figure 22),
- Keep on erecting the wall around the frame,
- When the wall reaches the top of the frame, finish with two beams (4' long, section 4"x3") put on both sides of the wall so that they support one (or 2 small) horizontal 1" thick, 3'6" long and 1'10" wide plank (picture 23),
- Keep on constructing the double wall above the door according to the shape (figure 23),
- Install the door onto the frame (on hinges).

A second shutter covered by chicken mesh or metal bands can be added to the door so that when the greenhouse is ventilated by opening the main door, the second shutter is closed to avoid animals to enter inside (picture 24).

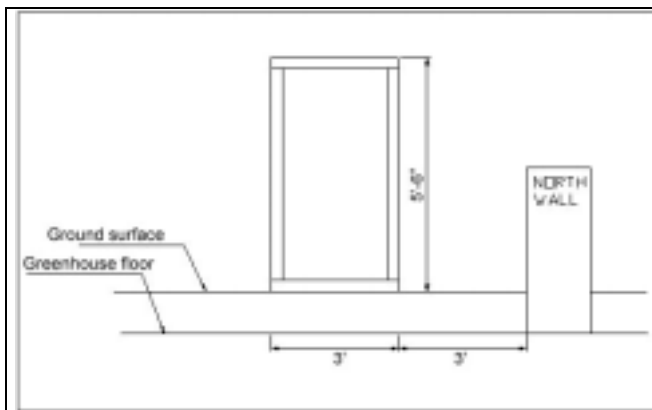

Figure 21 - Door positioning (elevation)

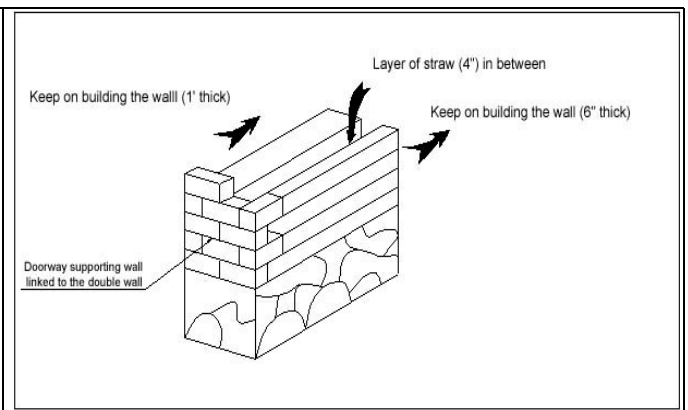

Figure 22 - Drawing of the masonry procedure for building the doorway supporting wall



Picture 23 - Detail of the masonry procedure for building the doorway supporting wall



Picture 24 - The second shutter covered by metal band

Technical Datasheet N°4: Installing a side shutter as ventilator

Principle:

In order to cool the greenhouse by natural ventilation, a side shutter has to be installed in the prolongation of the main door, on the opposite wall.

Carpentry:

The ventilator is composed of a fixed frame and an articulated window,

- Make the fixed frame : 2'x1'6" external dimension (picture 25),
- Now prepare the window which will be attached with hinges to the frame,
- Make a frame 1'2"x 1'4" with wooden battens (2"x1"1/2)
- Apply plywood on each side of the frame with insulator (straw, wild grass, sawdust) in between,
- Join the window to the frame by means of hinges.



Picture 25 - Making of ventilator frame.

Masonry:



Picture 26 - Frame positioning on wall

- Construct the double wall, as explained in datasheet N°2, on the opposite side of the door until this wall reaches 2'6" feet high from the ground,
- Find the correct location of the ventilator. It must be in the prolongation of the door, which means that the ventilator must be placed at 3'6" from the interior of the north wall .
- Install a layer of mud bricks horizontally, as shown in picture 26, which will become the basis of the ventilator installation,
- Install the window frame (opening 2'x1'6" external) into the middle of the wall width (picture 26),
- Keep on erecting the wall along the frame, leaving the opening all through the width of the wall.
- When the wall reach the top of the frame, finish with one (or 2 superposed) horizontal 1" thick, 2'6"long and 1'6"wide planks, or with several sticks (pictures 27 & 28).
- Cover the external side of the shutter with chicken mesh so that animals can enter inside the greenhouse (picture 27)

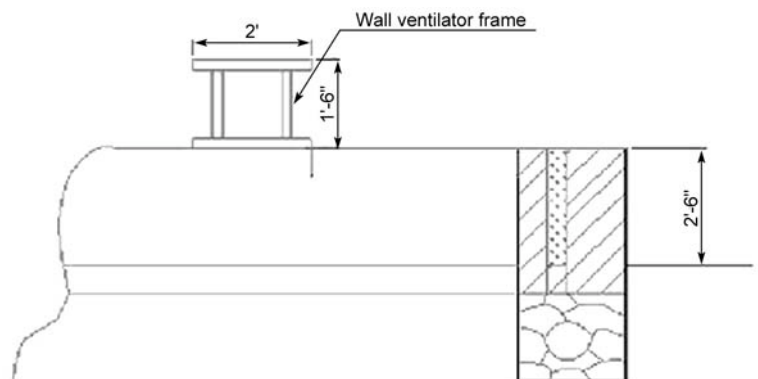

Figure 23 – Frame installation



Pictures 27 & 28 - View of installed side shutter with chicken mesh outside

Technical Datasheet N°5: Building a partition wall

Principal

For greenhouses built over 13,500 feet above sea level, internal partition walls are installed to increase thermal mass of the greenhouse.

Moreover, by building such internal walls, wooden pillars generally used to load the roof structure may be avoided.

Installation procedure

- In order to give enough strength to the partition walls, they must be taken into consideration during the foundation drawing.
- When the north side wall is being built, start erecting at the same time the partition walls as shown in figure 24.

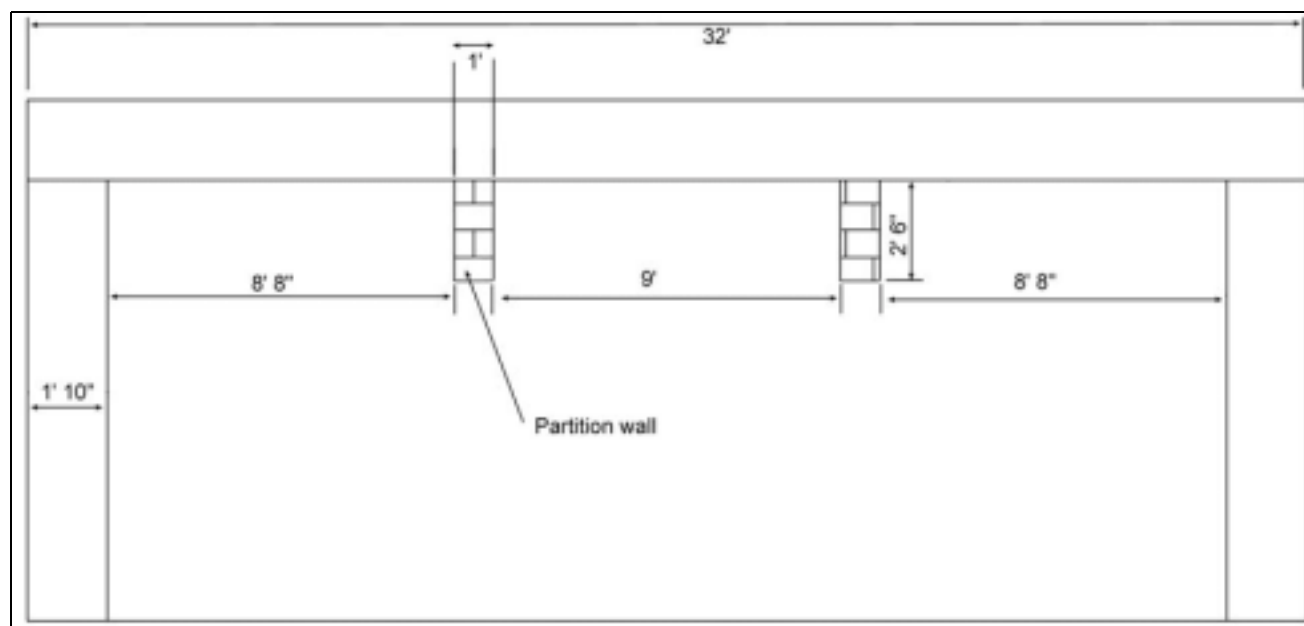

Figure 24 - Plan view of greenhouse with partition walls constructed

- When both the west and east side walls reach 4', a slope must be introduced (as explained in datasheet 6). Apply the same recommendation for the partition walls (picture 29).



Technical Datasheet N°6: Installing a roof on a greenhouse

Part I: Masonry

Building of the north wall and sides walls of the greenhouse in order to sustain the roof.

- Start erecting the north wall and side walls following the guidelines given in the double wall technical datasheet N°2.
- When the north wall reaches 4' high, **build a single line of bricks** on external side (see figure 25) that will sustain the roof material. Stop building the north wall.
- The slope has now to be taken in consideration. The following method helps to mark the mark side walls and to determine the top of the greenhouse : start from the lowest point of the roof (4' high from ground, inner side), then move 4'6" to the interior of the greenhouse and elevate 3'6" from that point so that it forms a 30° angle. To do so, use the rope and stakes method (datasheet N°2, see also figure 25).
- Install 1 or 2 vertical posts (oil covered). They will support the roof.
- To support the roof, beams must be installed. Prepare 2 wooden beams 6" diameter, the same length as the greenhouse (wall included). You can also use several beams joined together to reach that length. Cover them with oil to make them moisture resistant. The beam can be fixed on the post by 2 techniques (see pictures 30 & 31)



Pictures 30 & 31 - Beam fixation on the post in Ladakh (left) and Qinghai (right)

- Embed them on the side walls as shown in figure 25.
- From the middle of the top beam, add on beam toward north and one beam toward south to stabilised the structure (see picture 40, data sheet n° 7)
- Install the top ventilators frames as explain in datasheet N°8.



Picture 32 - View of a general greenhouse structure

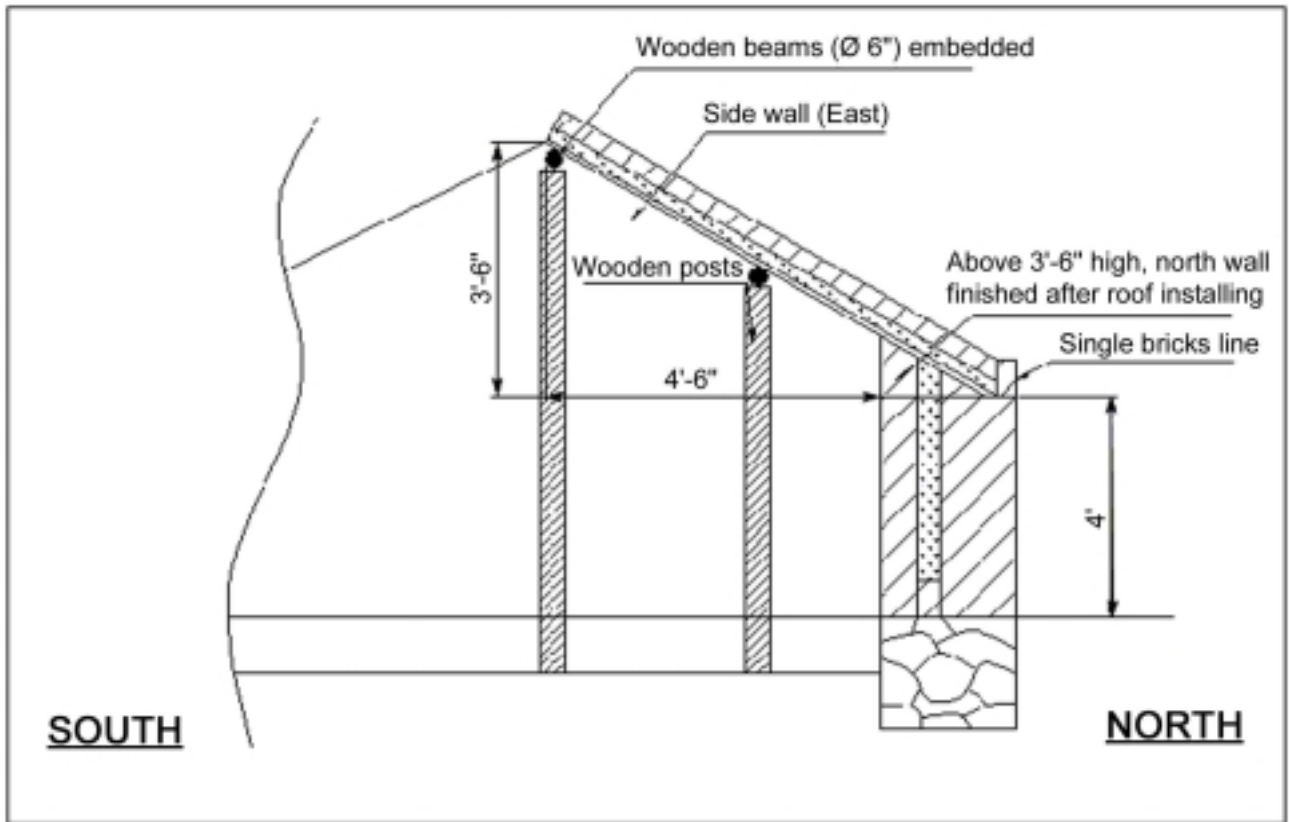

Figure 25 - Wall building, beam positioning

If wooden beams are cheap, a stronger roof can be constructed by a single horizontal top beam (6" diameter), transversal joists (4" diameter) every 2 feet resting at the bottom on the north wall and at the top on the horizontal beam (see picture 33)



Picture 33 - One horizontal beam and several transversal joists in Spiti

Part II: Roofing

When the roof structure is ready, start building the roof (figure 26):

- Install sticks (diameter 1") on the beams (picture 34). These sticks may be nailed on top of the structure to avoid bending. The single mud brick line previously built should support the sticks.
- Put cardboard or bags over the sticks to cover them,
- Lay straw over the cardboard (or bags), from 1" to 2" thick depending on altitude (see designs)
- Then apply a 3" thick mud Pushka layer (picture 36).

In rainy area, a small overhang (6") can be added on the backside of the greenhouse to protect the wall from the rain (picture 35).



Picture 34 - View of sticks

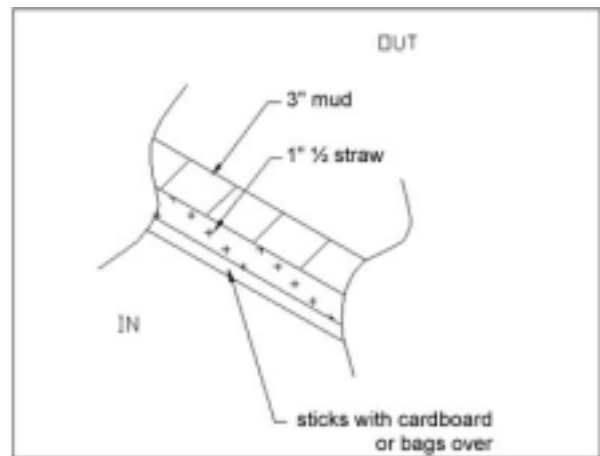

Figure 26 - Roof composition



Picture 35 - Small overhang on the backside of the greenhouse in Spiti



Picture 36 – Applying of cardboard, straw and Mud

Do not use polythene film as a layer of the roof composition. Otherwise, the sticks will rot. The roof has to breathe in order to avoid trapping moisture.

A white cloth may be added under the roof to increase the insulation and reflect more solar radiation onto the crops (picture 37).



Picture 37 - White cloth under the roof

In some place, such as Qinghai, timber and bamboo are cheaper than beam and bamboo (picture 38). The bamboo net are nailed on the wooden joist (picture 39)



Picture 38 & 39 - A roof structure made of timber and bamboo in Qinghai

Technical Datasheet N°7: Installing polythene film

Structure:

The polythene is supported by a wooden structure or reused steel pipe. The wooden structure is (figure 27 and picture 40) described below :

- Select 2 wooden posts (4" diameter, 5' long) and 3 wooden beams (3" x 2" section and 12' long). Round beam are also suitable.
- Fix the 2 posts at 9' from each side wall, on a line 2' away from the south side of the greenhouse (the wall axe) 6" deep such as their top reaches the wall angle level.
- Fix the wooden beams (3" x 2") on the post top, embedded on the top angle of each side wall and nail them on the wooden post.
- Add wooden joists (3" x 2") between this middle support and the top beam above each post. These joists should not rest directly on earth: this can lead to massive damage and exfoliation of the earth (picture 41)

Make the wooden support as smooth as possible, especially the angle, in order to preserve the polythene. Cloth can also be added between the wooden beams and the polythene film.

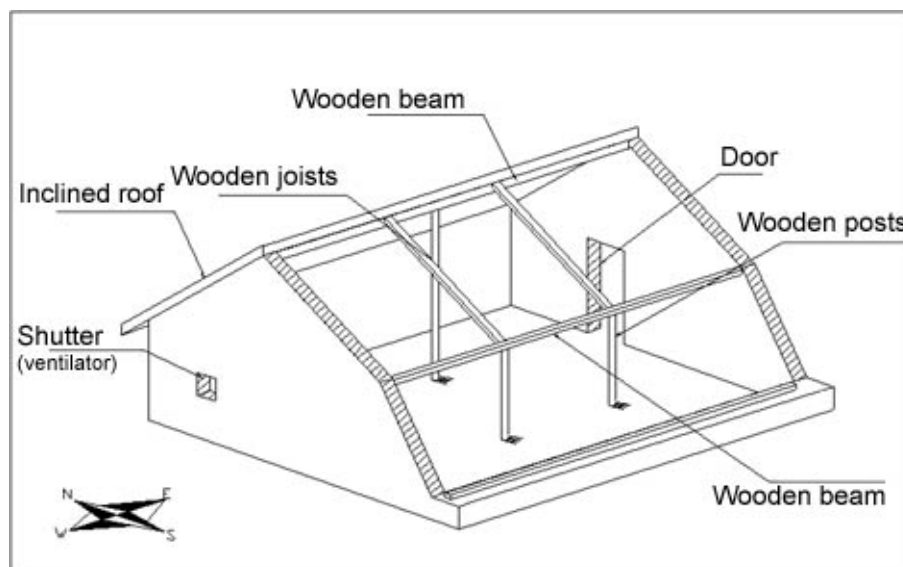

Figure 27 - Wooden support for polythene



Picture 40 - Wooden structure to support polythene (Lowgar, Afghanistan)



Picture 41 - Earth exfoliation due to joists resting directly on the earth

Attaching a polythene cover:

- Purchase a UV resistant polythene film at least 32 feet long and 20 feet wide.
- During the warmest period of a sunny day, lay it on the greenhouse from the top to the bottom.
- Fix the polythene at the top by rolling it around a beam or a pipe and by fixing it with a brick layer laid over bags or with a earth coating in order not to damage the polythene.
- On the side, polythene is fixed with cement bag filled by sand or bricks laid on a mud coating (picture 42)
- At the bottom, tie it as strongly as possible and fix it using a brick layer laid over bags or an earth coating and cover the area with earth (see picture 43).
- The roof has to breath: do not cover the roof with polythene in other case the wood and straw will rot.

The polythene will be stretched to a maximum if it is tightly tied and doesn't vibrate with the wind. That's why, as polythene expands with heat, it should be fixed during the warmest hour of a sunny day.



Picture 42 - Detail of polythene fixing by use of bricks laid on a mud coating.



Picture 43 - General view of polythene fixing by use of bricks.

Recommendation for windy weather:

In case of windy weather, the polythene sheet must be supported in order not to be damaged. To do so, place over the installed polythene sheet, a rope net which will add load to the greenhouse and minimise wind effects on the plastic. Then install tightly, below the polythene, another rope net between the middle beam and the top beam (see figure 28).

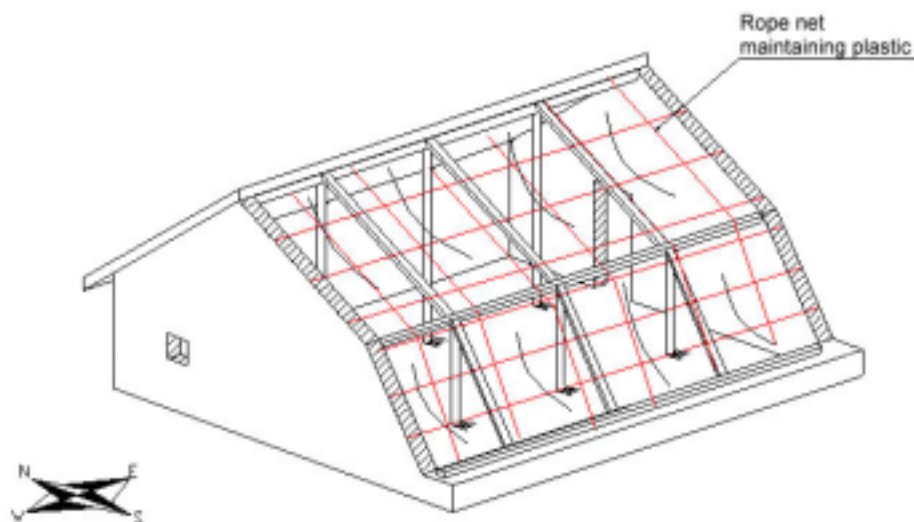

Figure 28 - Rope net maintaining polyethylene sheet in case of windy weather

Recommendation for hot climate during summer time:

In continental climate, the summer period can be very hot (eg Kabul in Afghanistan), it is recommended to improve the ventilation by enlarging the surface that can be opened, especially in the lower part of greenhouse for air inlet: for example by lifting polythene on its south face (picture 44) or adding operable frame covered by polythene. These openings must be tightly shut in case of strong wind.



Picture 44 - South face of polythene lifted to improve cooling

Technical Datasheet N°8: Installing a shutter on the roof as ventilator

Concept:

From April to September, a greenhouse can be very hot and reaches 45°C, this overheating may damage the vegetables : when the interior temperature is above 28°C, the greenhouse has to be cooled. Natural ventilation is an efficient system to cool a greenhouse : the warm air rises ; if the cooler ambient air enters from openings located at the bottom of the greenhouse such as the door or the wall ventilator, the warm air will be evacuated through the top if some openings are provided. Thus 2 roof ventilators are installed in the roof of the greenhouse (or only one for design II, III and IV greenhouses) - See figure 29.

When the interior temperature is above 28°C, all ventilators are opened to cool the greenhouse. When the temperature is lower than 28°C, they are closed.

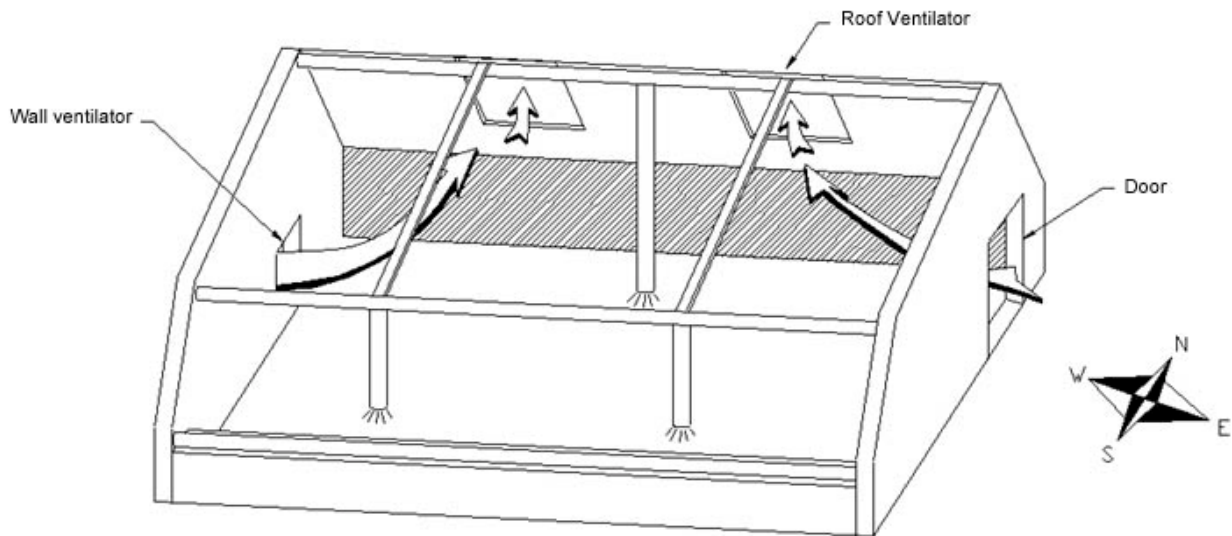

Figure 29 - View of air circulation through roof ventilator

Carpentry:

The roof ventilator is made of a wooden frame supporting an insulated manually operated shutter. This shutter is attached by a hinge fixed at the top of the frame.

The frame is 4 feet by 3 feet, made of 4'' by 3'' wooden beams. The inner edges are cut (1''x 1''1/2) in order to fix the shutter and make the shutter/frame joint air tight (figure 30).

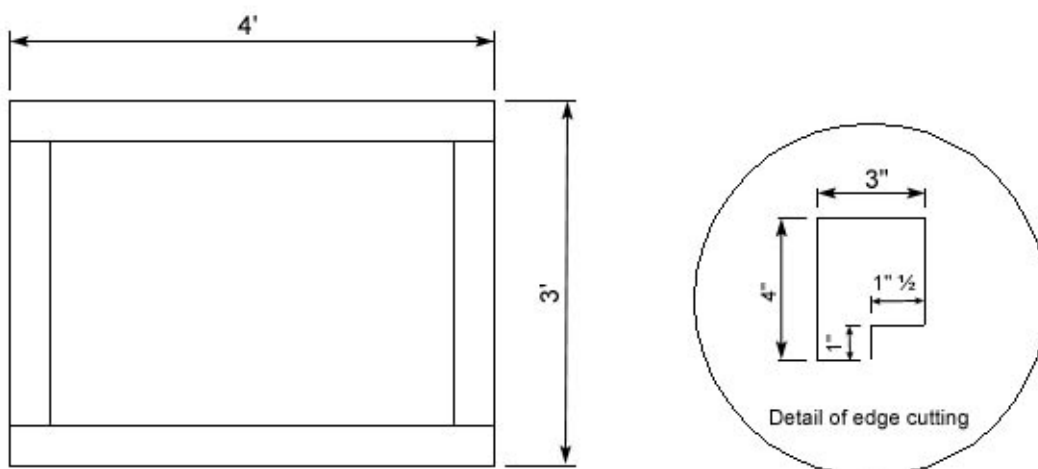

Figure 30 - Details of frame construction

The shutter construction method is similar to the door and wall ventilator shutter: the wooden frame is a sandwich made by a 4mm plywood (on the lower side) and a metal sheet (on the upper side). The inner space is filled with insulation material. First build the frame using 2" x 2" wooden pieces, then nail one piece of plywood onto the frame and fill the space with insulator before nailing the other plywood piece onto the frame.

The best insulation material is "machine straw", but straw, wood shavings and horse dung are also suitable. Sawdust and goat dung, that may leak, have to be avoided.

The inner side of the shutter is painted white in order to reflect the solar radiation to the crops. A coating of waterproof paint can be added on the outer side of the shutter to protect the metal sheet from alteration and water infiltration.

Implementation:

The 2 roof ventilator frames are installed during the roof structure construction (picture 45). They are located 8 feet from the side walls on the top of the roof. For design II to IV greenhouses, only one roof ventilator is installed in the middle of the roof.



Picture 45 & 46- Views of roof ventilator implementation and operating

The shutters are added after the completion of the roof. They are fixed on the top frame and rubber is applied between the shutter/frame joint to make it air tight when the ventilators are closed during night time (picture 46).

An iron bar has to be fixed onto the shutter to facilitate the operation (picture 47).



Picture 47 - Top view of roof ventilator

Technical Datasheet N°9: Providing night insulation

Concept:

As the heat loss through the polythene is very high, a greenhouse is very cold during the night and vegetable growing is limited : a manually operated insulator has to be drawn after the sunset and removed at sunrise. A cloth, added under the polythene, could act as a good insulator. Heat loss is divided by two and the interior temperature is 5°C warmer. Insulation will be effective if an air gap remains between the polythene and the cloth. But this air has to be trapped : the cloth has to be air-tight and the space between the cloth and the polythene sealed on the top, bottom and sides.

Construction:

The cloth (e.g. parachute) is attached on the top and bottom by rings sliding on a pipe or an iron wire and supported in the middle by 2 steel wires. The insulation is composed of several parts corresponding to the parts drawn by the posts in the greenhouse. The insulation is operated from the middle to the sides : during day time, it is removed to the side walls (picture 48).

The insulation has to remain close to the polythene so as not to damage the vegetables (figure 31).

- Fix the pipe or the steel wire at the top and bottom of each part of the greenhouse. A ring is required every 12" to support the insulation (figure 32).
- Fix the 2 steel wires : the first one is below the top wall angle and the second one is between the angle and the roof beams.
- Cut the insulator so that it fits with the distance between the top pipe and the bottom pipe via the 2 supports.
- Lay the insulator over the 2 supports and fix it to the ring at the top and bottom.
- Seal the air gap at the top and bottom by a 4" high cloth fringe along the whole length of the greenhouse.

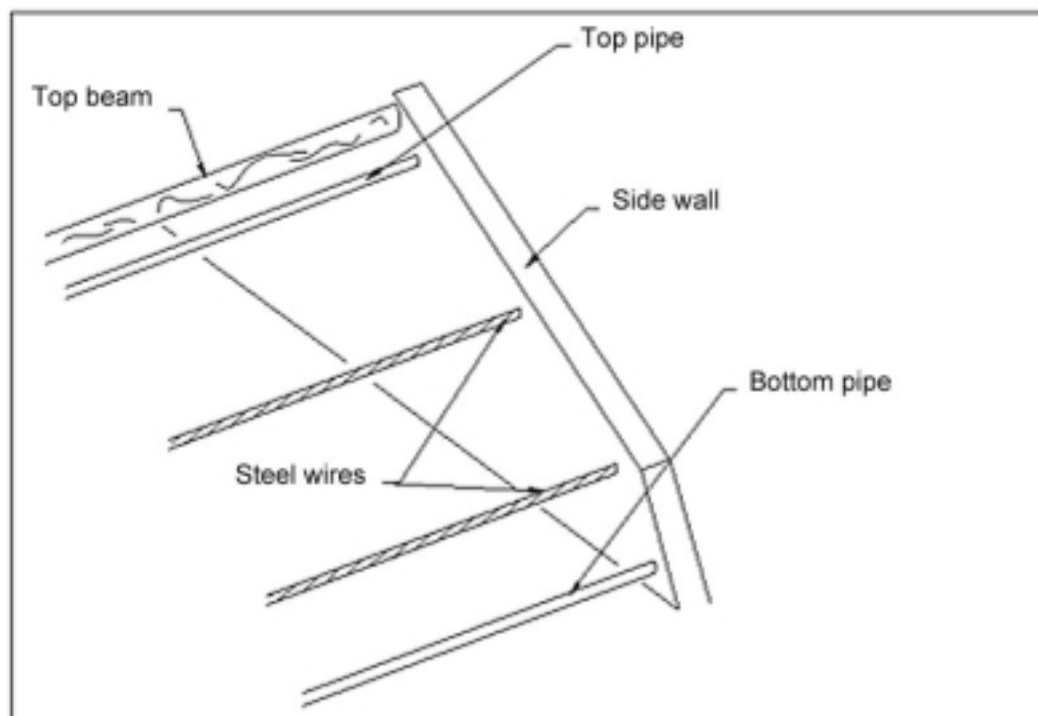

Figure 31 - View of insulation support installation



Picture 48 - View of installed night insulation

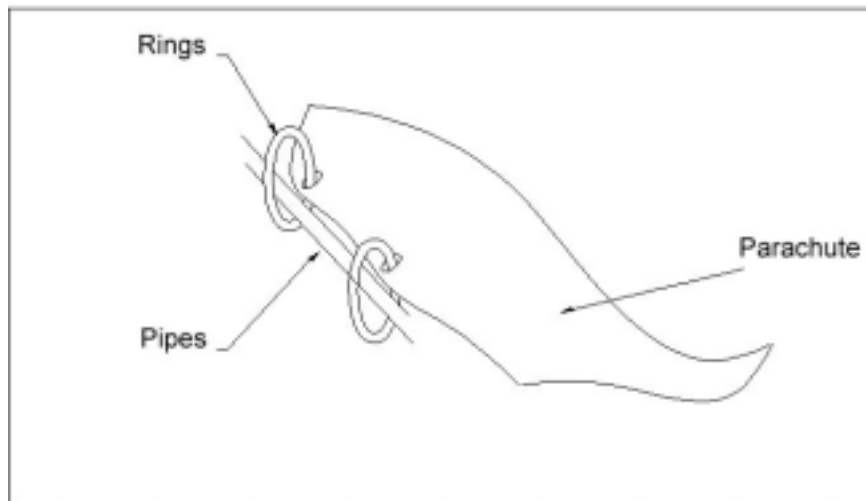

Figure 32 - Details of cloth fixing on pipe (sliding device)

Technical Datasheet N°10 Material listing and cost estimate

The following table sums up the materials needed per task and the relative costs (April 2002, Leh, Ladakh in Indian Roupies)

Table 9 - Material listing and cost estimate

I.N	Item	Quantity	Materials unit	Cost/unit Rs	Total Rs	Skilled labour		Unskilled labour		Labour Total Rs	Labour and Materials Rs
						Number of days	rate/day Rs	Number of days	rate/day Rs		
1	foundation										
	excavation	430	cft	0	0	0	250	2	150	300	300
	stone foundation	234	cft	6,85	1602,9	1,5	250	3	150	825	2427,9
	sub total				1602,9					1125	2727,9
2	walls										
	bricks	1500	pieces	1,9	2850	3	250	7	150	1800	4650
	sawdust	10	bags	35	350	0	250	0	150	0	350
	seabuckthorn				200	0	250	0	150	0	200
					3400					1800	5200
3	wall finishing										
	plaster	460	sqft	0,6	276	1	250	1	150	400	676
	whitewashing	60	sqft	1	60	0	250	0	150	0	60
	painting (black)	160	sqft	1	160	0	250	0	150	0	160
					496					400	896
4	roof										
	beam- douma 16'	4	piece	400	1600	1,5	250	3	150	825	2425
	post	6	piece	100	600					0	600
	sticks-talboo 6'	200	piece	10	2000					0	2000
	cardboard	200	sqft	2	400					0	400
	straw	4	bag	130	520	0	250	0	150	0	520
	mud puska	100	cft	2	200	0	250	0	150	0	200

5	polythene										
	wooden frame									0	0
	beams 3"*2"*32'	1,33	cft	350	465,5					0	465,5
	pillar 3"*2"*4*3	0,5	cft	350	175					0	175
	joist (optional)	1,5	cft	350	525					0	525
	empty bags				200						
	polythene				2000	1	250	2	150	550	2550
					3365,5					550	3715,5
6	door										
	plank	6	sqft	30	180	0,5	250	0,5	150	200	380
	wooden frame (4"*3"*20')	1,66	cft	300	498					0	498
	wooden frame (1"*2"*20')	0,3	cft	300	90					0	90
	straw	0,5	bag	150	75					0	75
	nail				80					0	80
	plywood 3mm	30	sqft	17	510					0	510
					1433					200	1633
7	cross ventilator										
	plywood	8	sqft	17	136	0,25	250	0	150	62,5	198,5
	frame	0,5	sqft	300	150					0	150
	nails; iron sticks				50					0	0
					336					62,5	348,5
8	Night insulation										
	cloth	420	sqft	2	840	1	250	1	150	400	1240
	wire	84	ft	3	252					0	252
	ring	32	pieces	2	64					0	64
	bottom				50					0	50
					1206					400	1606
9	ventilator										
	top ventilator	850	piece	2	1700					0	1700
	Total				18859					5362,5	23971,9

Rmq: east face = 58 sqft north face = 112 sqft

ANNEXES

4 designs according to the site and to the altitude with dimensions in centimetres [see chapter IV - part A]

